

INSTRUCTION MANUAL

1/10TH SCALE 4WD ELECTRIC POWER RADIO CONTROLLED VEHICLES

Number Description



In order to understand our company products more expediently, please check it according to the part number.

- A1 Car/Drift Car**
- A2 Brushless Car/Drift Car**
- B1 Buggy**
- B2 Brushless Buggy**
- C1 Rally Monster**
- C2 Brushless Rally Monster**
- D1 Truck**
- D2 Brushless Truck**
- E1 Truggy**
- E2 Brushless Truggy**



Electric power models went quite popular nowadays and attracted more and more operators. We manufactured a series of 1/10 electric power models and many high quality aluminum parts.

Notes:

- ⇒ Read and understand the instructions carefully before operating or assembling your racing model.
- ⇒ Specifications are subject to change without prior notice, and actual received model may vary from the images and/or descriptions in this manual.

ITEM NO.	STYLES	LENGTH	WIDTH	WHEEL BASE	DRIVE SYSTEM	GEAR RATIO	GROUND CLEARANCE	DIAMETER OF WHEEL	WIDTH OF WHEEL	MOTOR	ESC	BATTERY	SPEED
A1	on-road car/Drift	360mm	200mm	260mm	4WD Shaft Drive	1:6.263	4.5mm	65mm	26mm	Rc540	Sp03018	7.2V,1800mAh NI-MH	28KM
A2	Brushless car/Drift	400mm	380mm	260mm	4WD Shaft Drive	1:5.719	4.5mm	65mm	26mm	Brushless 3300KV	Brushless 75A	7.2V,2000mAh NI-MH	35KM
TOP	Brushless car/Drift	400mm	380mm	260mm	4WD Shaft Drive	1:5.719	4.5mm	65mm	26mm	Brushless 2724KV	Brushless 80A w/Fan	LiPO-11.1V-3600mAh 25C	60KM
B1	off-road buggy	400mm	250mm	275mm	4WD Shaft Drive	1:7.737	26mm	86mm	32mm(F) 40mm(R)	Rc540	Sp03018	7.2V,1800mAh NI-MH	28KM
B2	Brushless buggy	400mm	250mm	275mm	4WD Shaft Drive	1:6.923	26mm	86mm	32mm(F) 40mm(R)	Brushless 3300KV	Brushless 75A	7.2V,2000mAh NI-MH	41KM
TOP	Brushless buggy	400mm	250mm	275mm	4WD Shaft Drive	1:6.923	26mm	86mm	32mm(F) 40mm(R)	Brushless 2724KV	Brushless 80A w/Fan	LiPO-11.1V-3600mAh 25C	62KM
C1	rally monster	460mm	250mm	275mm	4WD Shaft Drive	1:7.737	26mm	86mm	42mm	Rc540	Sp03018	7.2V,1800mAh NI-MH	30KM
C2	Brushless rally monster	460mm	250mm	275mm	4WD Shaft Drive	1:6.923	26mm	86mm	42mm	Brushless 3300KV	Brushless 75A	7.2V,2000mAh NI-MH	40KM
TOP	Brushless rally monster	460mm	250mm	275mm	4WD Shaft Drive	1:6.923	26mm	86mm	42mm	Brushless 2724KV	Brushless 80A w/Fan	LiPO-11.1V-3600mAh 25C	62KM
D1	off-road truck	400mm	310mm	275mm	4WD Shaft Drive	1:10.118	32mm	118mm	52mm	Rc540	Sp03018	7.2V,1800mAh NI-MH	28KM
D2	Brushless truck	400mm	310mm	275mm	4WD Shaft Drive	1:8.769	32mm	118mm	52mm	Brushless 3300KV	Brushless 75A	7.2V,2000mAh NI-MH	40KM
TOP	Brushless truck	400mm	310mm	275mm	4WD Shaft Drive	1:8.769	32mm	118mm	52mm	Brushless 2724KV	Brushless 80A w/Fan	LiPO-11.1V-3600mAh 25C	60KM
E1	off-road truggy	395mm	315mm	275mm	4WD Shaft Drive	1:10.118	35mm	105mm	60mm	Rc540	Sp03018	7.2V,1800mAh NI-MH	30KM
E2	Brushless truggy	395mm	315mm	275mm	4WD Shaft Drive	1:8.769	35mm	105mm	60mm	Brushless 3300KV	Brushless 75A	7.2V,2000mAh NI-MH	40KM
TOP	Brushless truggy	395mm	315mm	275mm	4WD Shaft Drive	1:8.769	35mm	105mm	60mm	Brushless 2724KV	Brushless 80A w/Fan	LiPO-11.1V-3600mAh 25C	62KM

NOTICE FOR ASSEMBLY

Additional Items Needed For Running Your Model

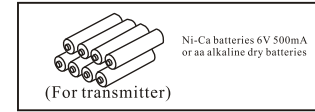

The following items , not included in the kit unless specified, are required for assembling your model. These items are available in local hobby shops.

Read and understand all instructions carefully before assembling your vehicle.

Tools Needed To Maintain Your Model

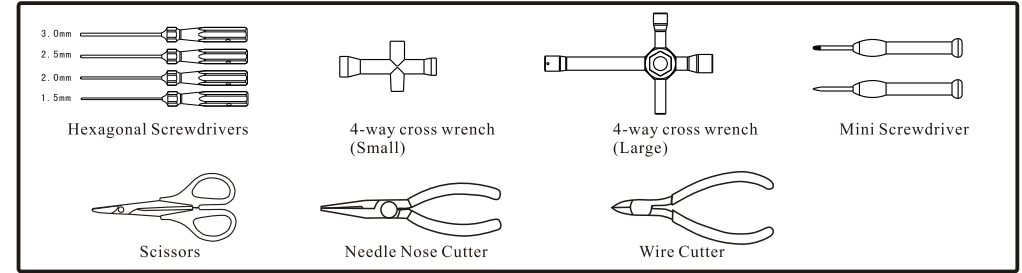

Use of the transmitter to control your EP vehicle...



This new kind of transmitter is recommended to 1/10th scale EP vehicles. Please install eight "AA" batteries to the transmitter.



Slide the battery cover to open the battery compartment.

Replace the battery cover after eight AA batteries are installed.

Battery Precautions:

1. In order to maintain good performance ,we warmly recommend you to use the 1.5V alkaline batteries instead of the 1.2 V chargeable batteries.
2. The batteries may leak in the event that they are installed with wrong polarities.
3. Do not use batteries of different types.
4. Do not mix the old and new batteries.
5. Do not leave batteries if not in use for a long period.
6. Please replace batteries when power indicators are weak.

Function Switches On This Transmitter

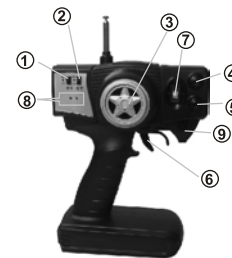

1. Throttle Reverse Switch
2. Steering Reverse Switch
3. Control Wheel
4. Steering Trim
5. Throttle Trim
6. Trigger
7. Crystal (To change please pull out)
8. Power Indicators
9. Trigger Setup Trim
10. Power Switch

How to drive forward, stop(break), and backward

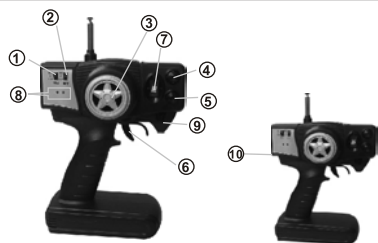

- | | |
|---------------------------|--------------------------------------|
| 1.Throttle Reverse Switch | 6.Trigger |
| 2.Steering Reverse Switch | 7.Crystal(To change please pull out) |
| 3.Control Wheel | 8.Power Indicators |
| 4.Steering Trim | 9.Trigger Setup Trim |
| 5.Throttle Trim | 10.Power Switch |



1. Trigger at the neutral position



2. Pull the trigger inward to drive the car forward.



3. Release the trigger back to neutral position to slow down the car.



4. Push the trigger outward to stop the car immediately completely (breaking)



5. Release the trigger back to the neutral position again (required step to activate the backward feature on the ESC)



6. Push the trigger outward again to drive the car backward.

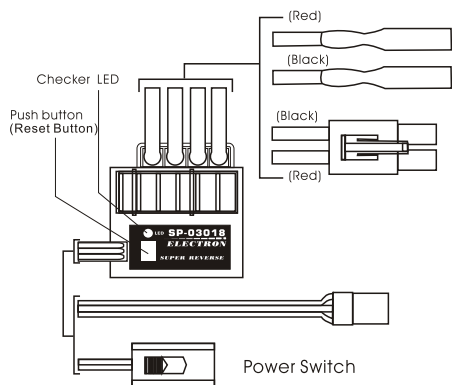

ESC Reset:

If the Sp03018 LED blinks rapidly, this indicates the ESC is in safe mode. Hold the Reset button on the ESC for 8 seconds until the LED blinks slowly, then power off and on the power switch to restart the system.

The ESC will be in safe mode in the following situations:











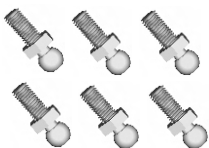

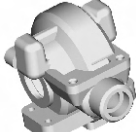



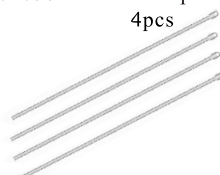





1. Out of the remote control range
2. Extra low/high voltage level from the power system is detected
3. External interference signal is detected.

1. Charge the battery for 8-10 hours for the first time usage. Do not charge the battery unattended.
2. When the car is blocked, do not continue to pull/push the trigger, this will cause the ESC to overheat and damage the ESC.



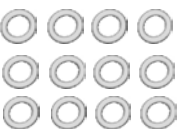







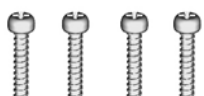
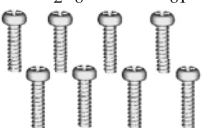
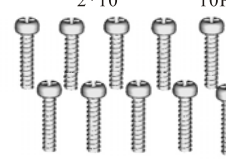
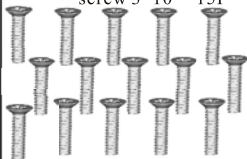
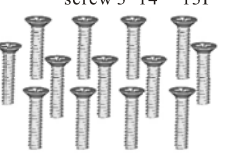

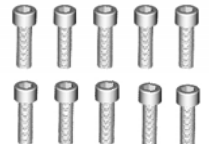
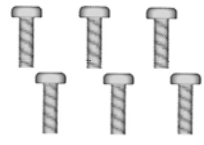



car/drift car(A1)/Brushless Car/Brushless drift car(A2)-spare parts

02002-Shock absorber 2pcs 	02003-Front dog bones Hole track:55mm Total length:61mm 2pcs 	02003T- Rear dog bones Hole track:54.5mm Total length:60mm 2pcs 	02005-Rear bumper 
02007-Rear lower suspension arm 2pcs 	02008-Front lower suspension arm 2pcs 	02009- Front Bumper Upper Cover 	02010- Body post 4pcs 
02012-Front/rear link 2pcs 	02013- Rear upright+ set screw 2pcs 	02014- Steering hub 2pcs 	02015- Front hub Carrier 2pcs 
02016-Universal joint Cup B 2pcs 	02017- Suspension arm reinforcement brace 2pcs 	02021-Rear arm holder 	02022-Front arm holder 
02025E-Steering set A 	02029- Crown gear 	02030T- Drive pinion complete 	02032-Universal joint Cup C 2pcs 
02033-Wheel axle 2pcs 	02035-Front shock tower 	02036-Front suspension arm pin A 2pcs 	02037-E-clip 12pcs (Φ7. Φ4. Φ2.5. Φ2.3) 





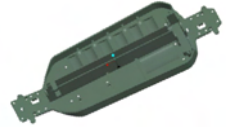





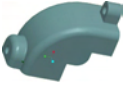





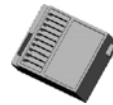
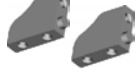

car/drift car(A1)/Brushless Car/Brushless drift car(A2)-spare parts

02038-Ball head screw 6pcs 	02039-Differential Box +Seals+washers 2pcs 	02042-Rear shock tower 	02051T-Gear box 
30311-Front bumper foam 	02053-Body clip 8pcs 	02055-Nylon locknut M4 	02057- Antenna Pipe 4pcs 
02061-Rear lower arm round pin B 2pcs 	02062-Front lower arm round pin B 2pcs 	02063-Rear suspension arm pin A 2pcs 	02064-Rear body post plate 
02066-Diff. Pinions/Pin 	03020-Receiver 	02372-Servo Arm  30312-Foam connect plate 	Sp3001-Servo(3Kgs) 
02074-Steering ackerman joint 	02075-Steering set B 	02077- Front bumper plate 	02078-O-Ring 12pcs 
02079-Oil bearing Ø15*Ø10*4- 6pcs 	02080-Oil bearing Ø5*Ø10*4- 8pcs 	02081- Round head screw 3*8 6P 	02082- Round head self-tapping screw 3*10 10P 









car/drift car(A1)/Brushless Car/Brushless drift car(A2)-spare parts

02083- Round head screw 3*12 6P 	02084- Round head screw 3*18 4P 	02085- Round head screw 2*8 8P 	02086- Round head screw 2*10 10P 
02087-Countersunk cross head self-tapping screw 3*10 15P 	02088- Countersunk cross head self-tapping screw 3*14 13P 	02089- Countersunk cross head self-tapping screw 3*15 9P 	02092-ISO 3*10 Screw 8pcs 
02093- Cap head screw M3*10 10P 	02096- Round head screw M3*10 6P 	02098-Grub screw M3*4 8P 	02099-Grub screw M4*4 10P 
02100- Wheel Hex. 8pcs 	02101-Steering bushing 12pcs 	02102-M3 nylon lock nut 6pcs 	02103- Zip tie 
02228-Star Style Spoke Wheel Rim 2P 	02116-Tyre 	02185-Wheel Complete (02116+02228) 2P 	02260-Tire Insert Sponge 2P 
03003-Center dogbone 	30716-Chassic 	30717-Radio Tray 	30718-Dustproof Cover 



























car/drift car(A1)/Brushless Car/Brushless drift car(A2)-spare parts











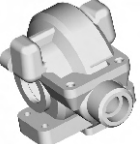

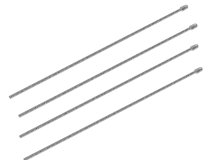
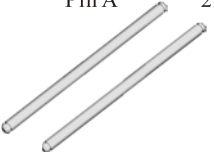



30719-Motor Gear Cover 	30720-Motor Mount 	03006- Antenna mount 	03010-Battery Cover 	03014-Battery (7.2v 1800mAh) 
03009-Battery cover post 	30313-Servo link 2P 	03011-Motor RC(540) 	03018-Electronic speed controller 	03013-Radio tray mount 
03015-Drive gear shaft +E-clips 	2530-Power Commutator 	02138-Ball Bearing $\phi 15 \times \phi 10 \times 4$ 6P 	02139-Ball Bearing $\phi 10 \times \phi 5 \times 4$ 8P 	02228PL (Gold) 02228PB (Blue) Chrome Plated Spoke Rim With Sprayed 2P  For on-road drift car only
09001- Tyre 2P  For on-road drift car only	07003- Drift Wheels Complete 2P  For on-road drift car only Blue/Gold/Green/Purple Spoke Rim Available	30313-Diff.main Gear (48T) 	30314-Motor Gear (21T)  For on-road car / pro.car(A1)	08027-Pin 2*10 10P 

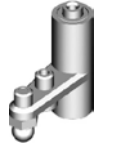
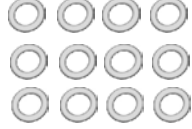
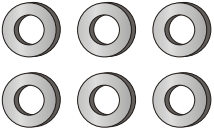
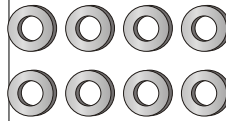

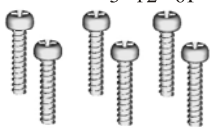
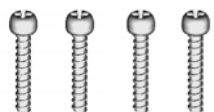

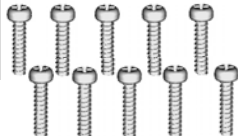
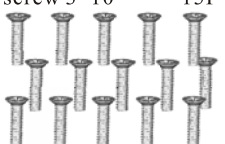





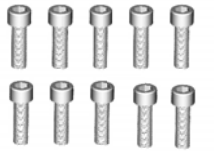
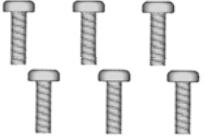







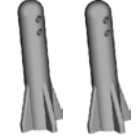

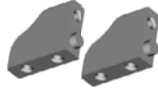
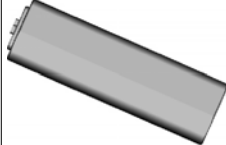
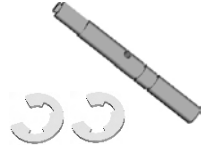
Brushless car/Brushless drift car(A2)-spare parts

102004-Aluminum Shock Absorber 2P 	03302-Brushless Motor KV:3300 	03307- Brushless Electronic Speed Control Output:75A 	02228PL (Gold) 02228PB (Blue) Chrome Plated Spoke Rim With Sprayed 2P 	102048-Aluminum Nut M3 8P 
102049-Aluminum Nut M4 4P 	02068- Wheel Mount Ball Bearings Complete $\phi 10 \times \phi 5 \times 4$ $\phi 15 \times \phi 10 \times 4$ 	03070-Battery Ni-MH (7.2V 2000mAh) 	11173-Motor gear (23T) 	

car/drift car(A1)/Brushless Car/Brushlessdrift car(A2)-upgradable optionals

102015-Universal Drive Joint 2P 	102004-Aluminum Shock Absorber 2P 	102042-Aluminum Wheel Hex. Mount 4P 	102037-Aluminum Body Post 4P 	102010-Aluminum Front Hub Carrier (L/R) 
102011-Aluminum Steering Hub(L/R) 	102012-Aluminum Rear Hub Carrier (L/R) 	102017-Aluminum Front/rear & Servo Link 2P 	102023-Aluminum Rear Shock Tower 	102019-Aluminum Front Lower Arm 2P 
102021-Aluminum Rear Lower Arm 2P 	102022-Aluminum Front Shock Tower 	102048-Aluminum Nut M3 8P 	102049-Aluminum Nut M4 4P 	03019 -Battery pack (7.2V,3000mAh) 
03404-Brushless Motor 2724KV 	03308- Brushless Electronic Speed Control Output:80A 	02228PL (Gold) 02228PB (Blue) Chrome Plated Spoke Rim With Sprayed 2P 	102040-Aluminum Ackerman Plate 	103071-Lightweight Motor Mount ★ 
102060-Aluminum Front Gear Box Mount 	102061-Aluminum Rear Gear Box Mount 	102058-Aluminum Front Bumper Upper Plate 	103022T-Carbon Fibre Front Shock ★ 	103023T-Carbon Fibre Rear Shock ★ 
28421-Lithium rechargeable battery (11.1V, 2200mAh) ★ 28424-Lithium rechargeable battery (7.4V, 2200mAh) 	03028- Fail Safe Taiwan 	11184-Diff.main gear steel (64T) 	11189-Motor gear steel (29T) 	03320- Fan-for ESC 







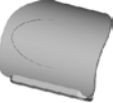

<p>02051T- Gear Box</p> 	<p>02053-Body clip 8P</p> 	<p>02055-M4 Nylon Nut 8P</p> 	<p>02057-Antenna Pipe 4P</p> 
<p>02063-Rear Lower Arm Round Pin A 2P</p> 	<p>02066-Diff.pinions+pin</p> 	<p>03020-Receiver</p> 	<p>02372-Servo arm</p> 
<p>Sp3001-Servo(3Kgs)</p> 	<p>02074-Steering ackerman joint</p> 	<p>02075-Steering Assembly B</p> 	<p>02078-O-Ring 12 P</p> 
<p>02079-Oil Bearing $\phi 15*\phi 10*4$ 6P</p> 	<p>02080-Oil Bearing $\phi 5*\phi 10*4$ 8P</p> 	<p>02081-Round head screw 3*8 6P</p> 	<p>02082-Round head screw 3*10 10P</p> 
<p>02083-Round head self-tapping screw 3*12 6P</p> 	<p>02084-Round head screw 3*18 4P</p> 	<p>02085-Round head screw 2*8 8P</p> 	<p>02086-Round head screw 2*10 10P</p> 
<p>02087-Countersunk cross head self-tapping screw 3*10 15P</p> 	<p>02088-Countersunk cross head self-tapping screw 3*14 13P</p> 	<p>02089-Countersunk cross head self-tapping screw 3*15 9P</p> 	<p>02092-ISO 3*10 Screw 8Pcs</p> 

<p>02093- Cap head screw M3*10 10P</p> 	<p>02096-M3*10 Cap head screw 6P</p> 	<p>02098-M3*3 Grub Hex. Screw 8P</p> 	<p>02099-M4*4 Grub Hex. Screw 10P</p> 
<p>02101-Steering bushing 12P</p> 	<p>02102-M3 Nylon nut 6P</p> 	<p>02103-Zip tie 6P</p> 	<p>02138- Ball bearing $\phi 15*\phi 10*4$ 6P</p> 
<p>02139- Ball bearing $\phi 10*\phi 5*4$ 8P</p> 	<p>03009- Battery cover post 2pcs</p> 	<p>03010- Battery cover</p> 	<p>03011- MotoRC(540)</p> 
<p>03013- Radio tray Holder A</p> 	<p>03014- Battery Pack (7.2V 1800mA)</p> 	<p>03015- Drive Gear Pin+E-Clip</p> 	<p>03018- Electronic Speed Controller</p> 
<p>04003- Centre drive joint</p> 	<p>04004- Battery Holder</p> 	<p>03300-Motor Heat proof Cover</p> 	<p>2530-Power Commutator</p> 
<p>11188- Diff. Main gear (48T)</p> 	<p>11177- Motor gear (17T) For off-road buggy(A1)/off-road truck(B1)</p> 	<p>30716-Chassic</p> 	<p>30717-Radio Tray</p> 

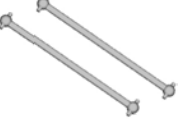

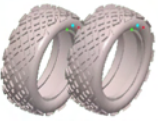
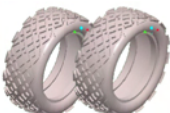

Buggy(B1)/Brushless buggy(B2)/Rally (C1)/BrushlessRally (C2)-spare parts

30718-Dustproof Cover 	30719-Motor Gear Cover 	30720-Motor Mount 	30721-Front Shock Tower 
30722-Rear Shock Tower 	30313-Servo link 2P 	08027-Pin 2*10 10P 	





off-road buggy(B1)/Brushless off-road buggy(B2)-spare parts

06003-Front Bumper 	06005-Wing Post 	06017-Wing Brace 2P 	06022-Front/rear dogbone 87mm*4 2P 	02005-Rear Bumper 
02100-Wheel Hex. 8P 	06101-Front Wheel Rims 2P 	06102-Rear Wheel Rims 2P 	30710-Tyre(Front) 2P 	30711-Tyre(Rear) 2P 
30712-Front Wheel Complete 2P 	30713-Rear Wheel Complete 2P 	30714-Front Body Post 	30715-Wing(PVC) 	06100-OLD Style Off-road Buggy Wing 



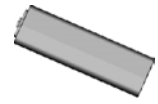

Brushless off-road buggy(B2)-spare parts

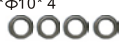
106004-Aluminum Shock Absorber 2P 	03302-Brushless Motor KV:3300 	03307-Brushless Electronic Speed Control Output:75A 	06101-Front Chrome Plated Spoke Rim 2P 	06102-Rear Chrome Plated Spoke Rim 2P 
--	--	--	---	---









Brushless off-road buggy(B2)-spare parts

102048-Aluminum Nut M3 8P 	102068-Wheel Mount Ball Bearings Complete φ10*φ5*4 	03070-Battery Ni-MH (7.2V 2000mAh) 	11179-Motor gear (19T) 	
102049-Aluminum Nut M4 4P 	φ15*φ10*4 			

rally monster(C1)/Brushless rally monster(C2)spare parts

17021-Front Bumper Set 	15504-Rear Bumper Set 	37011-Body Post 4P 	08059-Dogbone(F/R) 89.5mm 2P 	15506-Wheel Axle 2P 
08065-Wheel Hex. 4P 	15505-Rear Anti-Squat Plate 	15501-Tires(F/R) 2P 	15502-Wheel Complete (F/R) 2P 	62051-Ball Head Self-tapping screw (2.6*12) 4P 
06102-Wheel Rims 2P 	37010-Post Mount (Front)  (Rear) 			

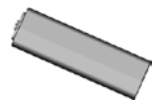
Brushless rally monster(C2)-spare parts







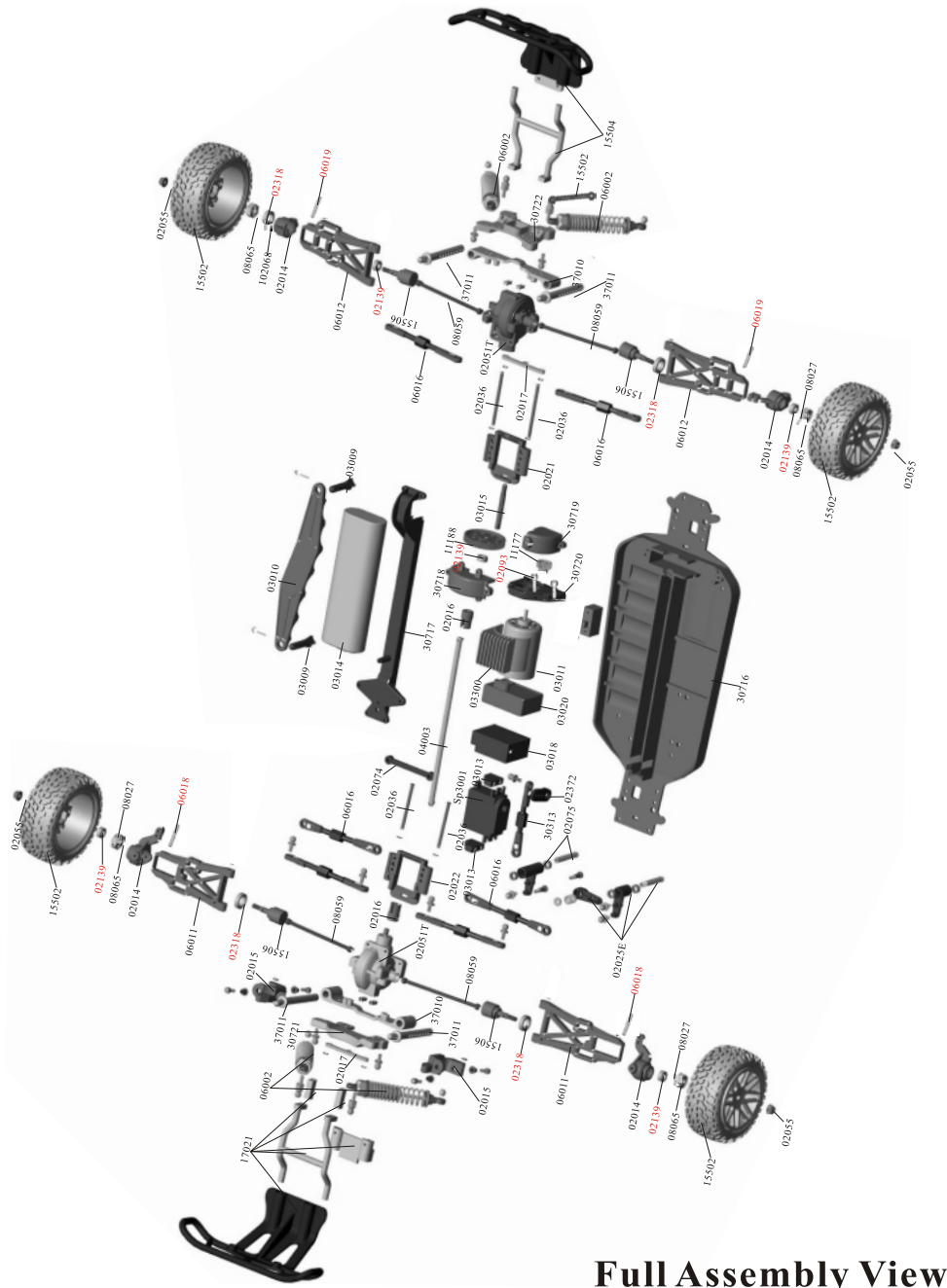











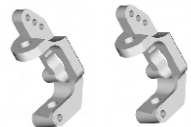

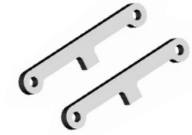
106004-Aluminum Shock Absorber 2P 	03302-Brushless Motor KV:3300 	03307-Brushless Electronic Speed Control Output:75A 	06102-Rear Chrome Plated Spoke Rim 2P 	102048-Aluminum Nut M3 8P 
102049-Aluminum Nut M4 4P 	102068-Wheel Mount Ball Bearings Complete φ10*φ5*4 	03070-Battery Ni-MH (7.2V 2000mAh) 	11179-Motor gear (19T) 	
	φ15*φ10*4 			

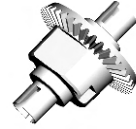
Rally Monster



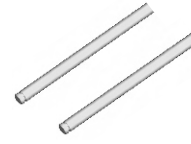

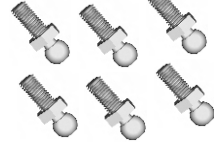
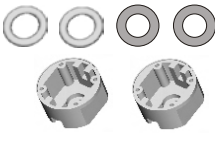
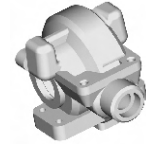





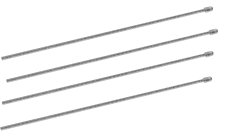





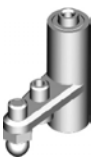
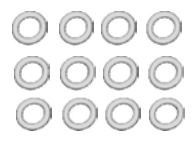
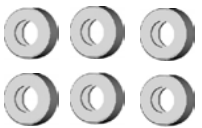

off-road truck(D1)/Brushless off-road truck(D2)-spare parts

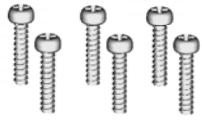







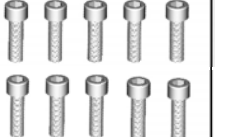
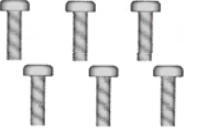









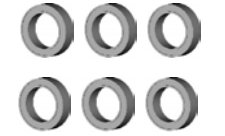

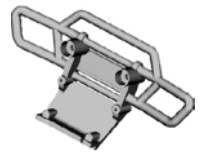



Full Assembly View

08001-Shock Absorber 	08008N-Wheel Rim 2P 	08009N-Tyre 2P 	08010N-Wheel Complete 2P 
08003-Rear bumper 	30313-Servo Link 2P 	02013-Rear upright +set screws 2P 	02014-Steering hubs 2P 
02015-Front hub carrier 2P 	02016-Universal Joint Cup B 2P 	02017-Suspension reinforcement brace 2P 	02021-Rear suspension arm Holder 
02022- Front suspension arm Holder 	02024T-Diff.gear complete 	08425E-Steering Assembly A 	02029-Diff.main gear 
02032-Universal Joint Cup C 2P 	02033-Wheel Axle 2P 	02036-Front Lower Arm Pin A 2P 	02037-E-Clip 12 pcs (Ø7. Ø4.Ø2.5.Ø2.3) 
02038-Ball Head Screw 6pcs 	02039-Diff. Box (with 2 Rings & Steel washers) 	02051T- Gear Box 	02053- Body clip 8P 

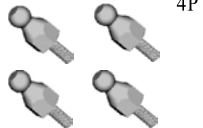
off-road truck(D1)/ Brushless off-road truck(D2)-spare parts

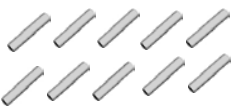
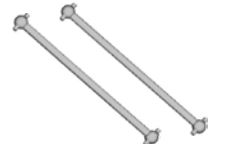
02055- M4 nylon nut 8P 	02057-Antenna Pipe 4P 	02063-Rear Lower 2P Arm Pin A 	02066- Diff.pinions+ pin 
03020-Receiver 	02372-Servo arm 2P 	Sp3001-Servo(3Kgs) 	02074-Steering Joint 
02075-Steering Assembly B 	02078-Seals 12P 	02079-Oil bearing $\phi 15*\phi 10*4$ - 6pcs 	02080-Oil bearing $\phi 5*\phi 10*4$ - 8pcs 
02081- Round head screw $3*8$ 6P 	02082- Round head self- tapping screw $3*10$ 10P 	02083- Round head screw $3*12$ 6P 	02084- Round head screw $3*18$ 4P 
02085- Round head screw $2*8$ 8P 	02086- Round head screw $2*10$ 10P 	02087- Countersunk cross head self-tapping screw $3*10$ 15P 	02088- Countersunk cross head self-tapping screw $3*14$ 13P 
02089- Countersunk cross head self-tapping screw $3*15$ 9P 	02092- ISO screw $3*10$ 8P 	02093- Cap head screw $M3*10$ 10P 	02096- Round head screw $M3*10$ 6P 

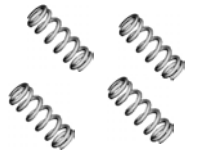







off-road truck(D1)/Brushless off-road truck(D2)-spare parts

02098- Grub screw $M3*4$ 8P 	02099- Grub screw $M4*4$ 8P 	02100- Wheel Hex. 8P 	02101-Steering Bushing 12P 
02102- M3 nylon lock nut 6P 	02103- Zip Tie 6P 	02138- Rolling Bearing $\phi 15*\phi 10*4$ - 6pcs 	02139- Rolling Bearing $\phi 10*\phi 5*4$ - 8pcs 
08002-Front bumper 	06007-Shock Ball Head 4P 	08005- Front Lower Suspension Arm 2P 	08006- Rear Lower Suspension Arm 2pcs 
08007-Body post 4P 	08012-Shock Tower 	08019-Rear Lower Arm Pin B 2pcs 	08020-Front Lower Arm Pin B 2p cs 
08021-Shock Ball Head Holder 4P 	08024- Discal screw $M3*10$ 8P 	08027-Pin 2*10 10P 	08029-Front/rear dogbone 88 mm 2P 
08028-Bump Post 4P 	08032-Bumper spring 4P 	08042- Front/rear link 2P 	03009- Battery cover post 



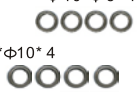

















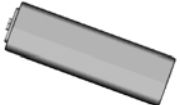

off-road truck(D1)/Brushless off-road truck(D2)-spare parts

03010- Battery cover 	03011- MotorRC(540) 	03013- Radio tray holder 	03015- Drive shaft+ E-clip 
03018- Electronic Speed Controller 	03014-Battery Pack (7.2V 1800mA) 	04003- Centre dogbone 	04004- Battery Corner Holder 
03300-Motor Heat proof Cover 	08003-Rear bumper 	08150-Tire Insert Sponge 2P 	2530-Power Commutator 
30716-Chassis 	30717-Radio Tray 	30718-Dustproof Cover 	30719-Motor Gear Cover 
30720-M otor Mount 	11188-Diff.main gear (48T) 	11183-Motor Gear (13T) For off-road truck(C1) 	08027-Pin 2*10 

Brushless off-road truck(D2)-spare parts

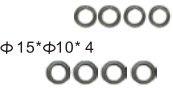
108004-Aluminum Shock Absorber 2P 	03302-Brushless Motor KV:3300 	03307- Brushless Electronic Speed Control 75A 	08008NPL (Gold) 08008NPB (Blue) Chrome Plated Spoke Rim With Sprayed 2P 	102068- Wheel Mount Ball Bearings Complete Φ 10*Φ 5* 4 Φ 15*Φ 10* 4 
102048-Aluminum Nut M3 8P 	102049-Aluminum Nut M4 4P 	03070-Battery Ni-MH (7.2V 2000mAh) 	11185-Motor Gear (15T) 	

truck(D1)/Brushless off-road truck(D2)-upgradable optionals

102010-Aluminum Front Hub Carrier (L/R) 	102011-Aluminum Steering Hub(L/R) 	102012-Aluminum Rear Hub Carrier (L/R) 	102042-Aluminum Wheel Hex. Mount 4P 	102048-Aluminum Nut M3 8P 
102049-Aluminum Nut M4 4P 	106017-Aluminum Front/rear & Servo Link 2P 	108015-Universal Drive Joint 2P 	108019-Aluminum Front Lower Arm 2P 	108021-Aluminum Rear Lower Arm 2P 
108022-Aluminum Shock Tower 	108037-Aluminum Body Post 4P 	108004-Aluminum Shock Absorber 2P 	03019-Battery pack (7.2V,3000mAh) 	03404-Brushless Motor 2724KV 
03308-Brushless Electronic Speed Control 80A 	08008NPL (Gold) 08008NPB (Blue) Chrome Plated Spoke Rim With Sprayed 2P 	102040-Aluminum Ackerman Plate 	102060-Aluminum Front Gear Box Mount 	102061-Aluminum Rear Gear Box Mount 
102068- Wheel Mount Ball Bearings Complete Φ 10*Φ 5* 4 Φ 15*Φ 10* 4 	03320- Fan-for ESC 	11184-Diff.main gear Steel (64T) 	11181-Motor Gear Steel (21T) For off-road truck(C1) 	

off-road truggy(E1)/Brushless off-road truggy(E2)-spare parts

off-road truggy(E1)/Brushless off-road truggy(E2)-spare parts

02086-Round head screw 2*10 10P 	02087-Countersunk cross head self-tapping screw 3*10 15P 	02088-Countersunk cross head self-tapping screw 3*14 13P 	02089-Countersunk cross head self-tapping screw 3*15 9P 	02092-ISO 3*10 Screw 8Pcs
02093- Cap head hex screw M3*10 10P 	02096-M3*10 Cap head screw 6P 	02138- Ball bearing Φ15*Φ 10*4 6P 	02139- Ball bearing Φ10*Φ5*4 8P 	03010- Battery cover
03011- Motor RC(540) for off-road truggy(2)(F1) only 	03013- Radio tray Holder A 	03014- Battery Pack (7.2V 1800mA) for off-road truggy(2)(F1) only 	03015- Drive Gear Pin +E-Clip 	03018- Electronic Speed Controller for off-road truggy(2)(F1) only
04003- Centre drive joint 	2530-Power Commutator 	04004- Battery Holder 	03300-Motor Heat proof Cover 	17701-Truggy Wheel Rim 2P
17702-Pre-mounted Truggy Tyre 2P 	17703-Truggy Wheel Complete 2P 	12001-Front Lower Arm 2P 	12002-Rear Lower Arm 2P 	12005-Front/rear link 4P
12006-Steering Link 2P 	12007-Front/rear dogbone 100mm*4 2P 	03009- Battery cover post 2pcs 	30716-Chassis 	30717-Radio Tray
30718-Dustproof Cover 	30719-Motor Gear Cover 	30720-Motor Mount 	30721-Front Shock Tower 	30722-Rear Shock Tower

37010-Post Mount 	11188-Diff.main gear (48T) 	11177-Motor gear (17T) For off-road truggy(D1) 	37011-Body Post 4P 	30313-Servo link 2P
08027-Pin 2*10 				

Brushless off-road truggy(E2)-spare parts

110004-Aluminum Shock Absorber 2P 	03302-Brushless Motor KV:3300 	03307- Brushless Electronic Speed Control 75A 	17701PL (Gold) 17701PB (Blue) Chrome Plated Spoke Rim With Sprayed 2P 	102068- Wheel Mount Ball Bearings Complete Φ10*Φ5*4 Φ15*Φ10*4
102048-Aluminum Nut M3 8P 	102049-Aluminum Nut M4 4P 	03070-Battery Ni-MH (7.2V 2000mAh) 	11179-Motor gear (19T) 	

off-road truggy(E1)/Brushless truggy(E2)-upgradable optionals

102010-Aluminum Front Hub Carrier (L/R) 	102011-Aluminum Steering Hub(L/R) 	102012-Aluminum Rear Hub Carrier (L/R) 	102042-Aluminum Wheel Hex. Mount 4P 	102048-Aluminum Nut M3 8P
102049-Aluminum Nut M4 4P 	106004-Aluminum Shock Absorber 2P 	106015-Universal Drive Joint 2P 	106017-Aluminum Front/rear & Servo Link 2P 	120101-Aluminum Front Lower Arm 2P
120102-Aluminum Rear Lower Arm 2P 	03404-Brushless Motor 2724KV 	03308-Brushless Electronic Speed Control 80A 	11184-Diff.main gear Steel (64T) 	11173-Motor gear Steel (23T)

off-road truggy

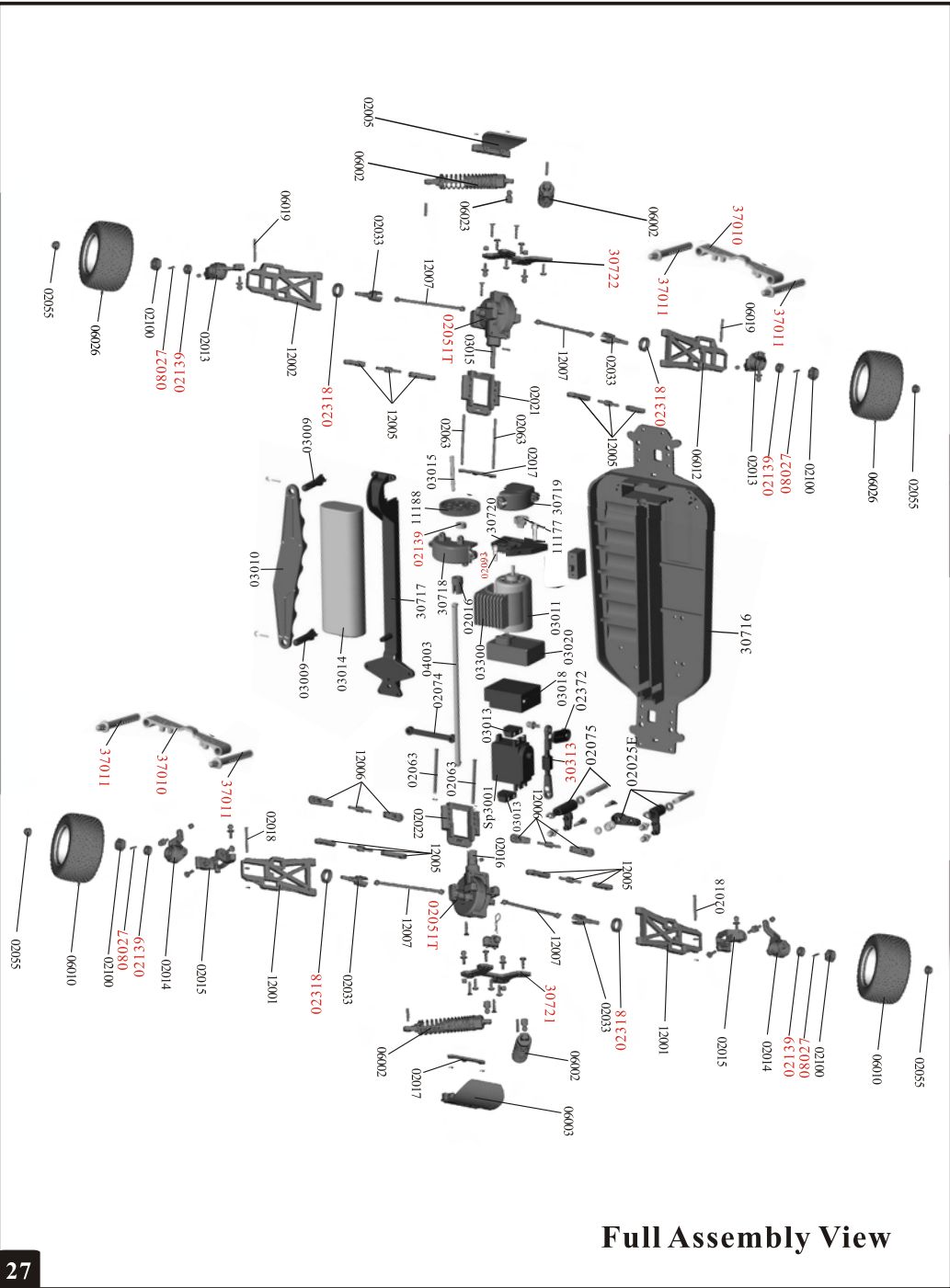

Full Assembly View