

# **INSTRUCTION MANUAL**

## **1/10th Scale 4WD Nitro Gas Power R/ C On-road Racing Cars /Off-road Buggies**

**A**  **1/10th scale  
on-road car**  
*Single Speed Transmission*



**B**  **1/10th scale  
on-road car**  
*Two Speed Transmission*

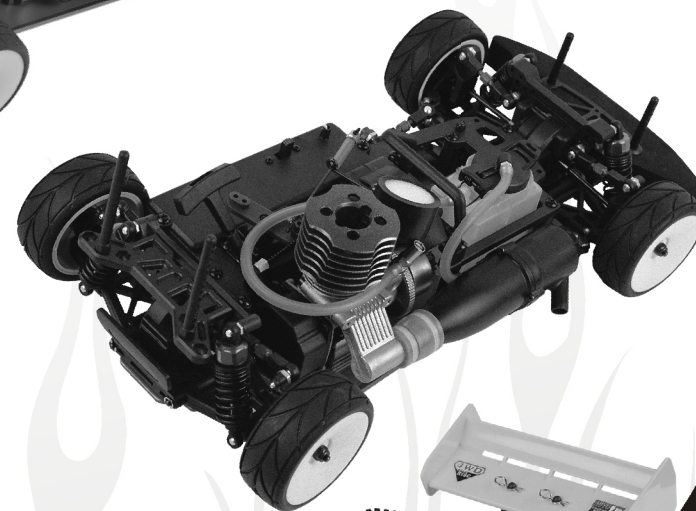

**C**  **1/10th scale  
off-road buggy**  
*Single Speed Transmission*

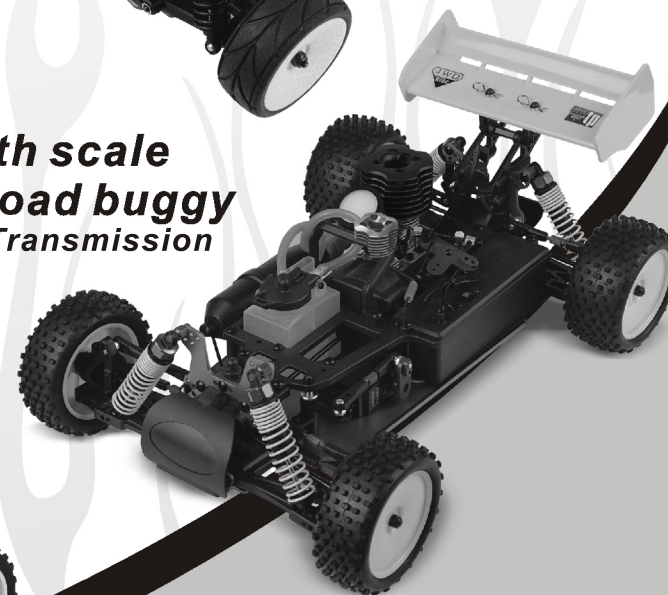

**D**  **1/10th scale  
off-road buggy**  
*Two Speed Transmission*



### *Notes:*

- ⇒ *Read and understand the instructions carefully before operating or assembling your racing model.*
- ⇒ *Specifications are subject to change without prior notice, and actual received model may vary from the images and/or descriptions in this manual.*

**NEW** 

**A: 1/10th scale nitro gas power R/C on-road touring car (single speed)**

Specifications: (Note: Specifications are subject to change without notice in advance!)

Length	Width	Height	Wheelbase	Ground Clearance	Gear Ratio	Dia./Width Of Wheel	Engine Level
360mm	200mm	112mm	260mm	4.5mm	1:7.67	Φ 65 *26mm	15-16 cpx required!

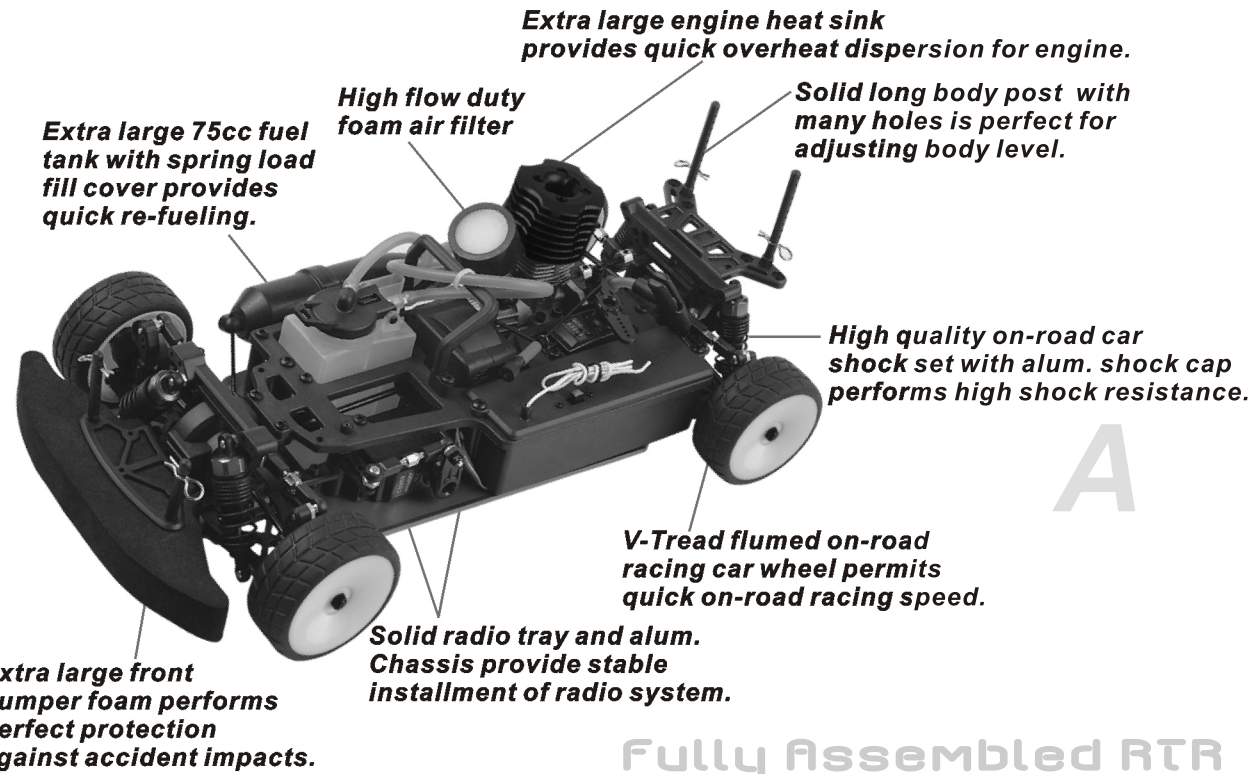

**B: 1/10th scale nitro gas power R/C on-road touring car (two speed)**

Specifications: (Note: Specifications are subject to change without notice in advance!)

Length	Width	Height	Wheelbase	Ground Clearance	Gear Ratio	Dia./Width Of Wheel	Engine Level
360mm	200mm	112mm	260mm	4.5mm	1:5.428(H) 1:8.038(L)	Φ 65 *26mm	16-18 cpx required!

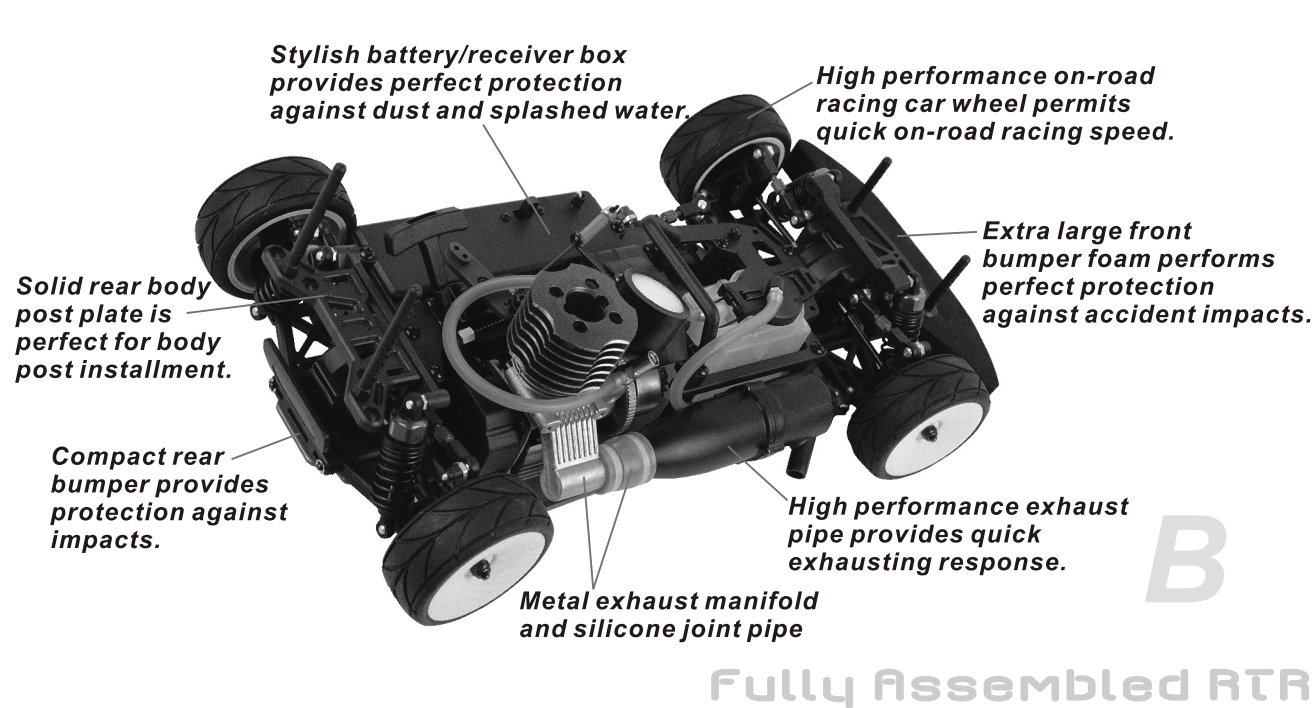

**C: 1/10th scale nitro gas power R/C off-road buggy (single speed)**

Specifications: (Note: Specifications are subject to change without notice in advance!)

Length	Width	Height	Wheelbase	Ground Clearance	Gear Ratio	Dia./Width Of Wheel	Engine Level
400mm	250mm	160mm	275mm	26mm	1:8.038	Φ86*32mm(F) Φ86*40mm(R)	15-16 cpx required!

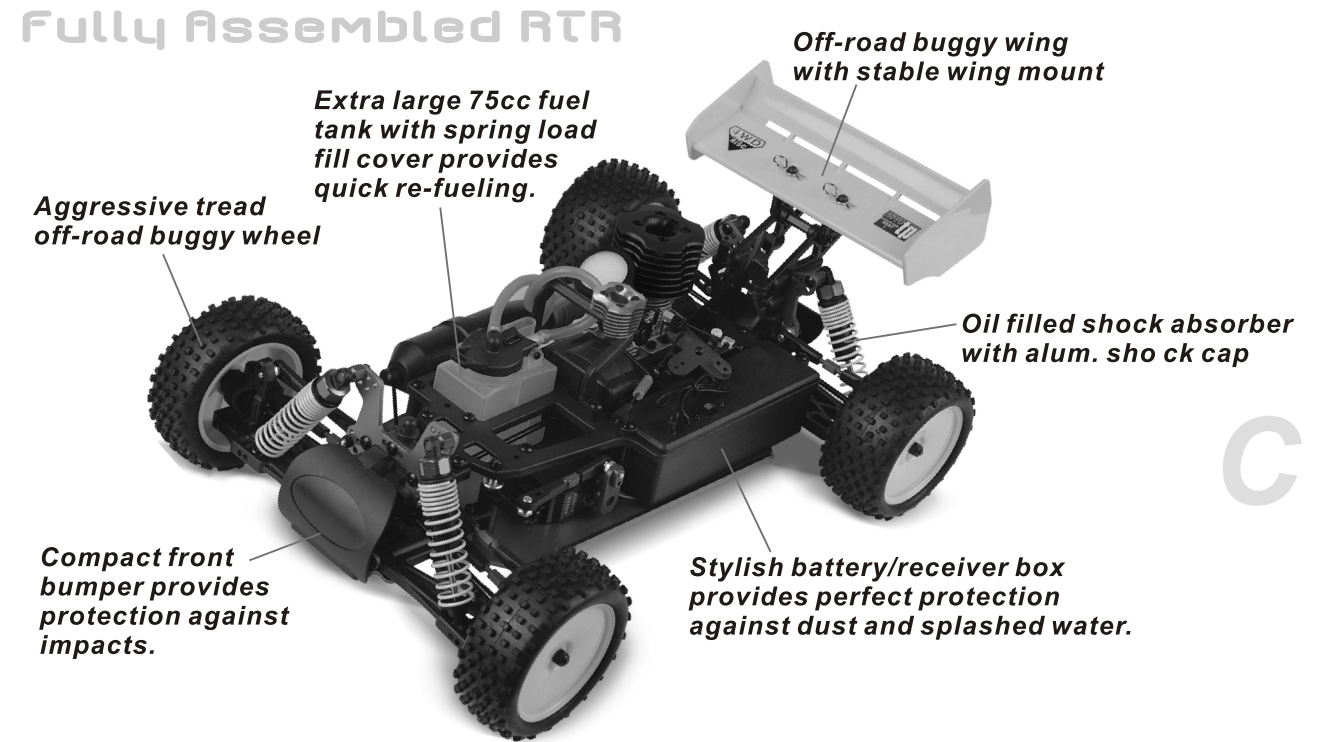

**B: 1/10th scale nitro gas power R/C off-road buggy (two speed)**

Specifications: (Note: Specifications are subject to change without notice in advance!)

Length	Width	Height	Wheelbase	Ground Clearance	Gear Ratio	Dia./Width Of Wheel	Engine Level
400mm	250mm	160mm	275mm	26mm	1:5.84(H) 1:8.58(L)	Φ86*32mm(F) Φ86*40mm(R)	16-18 cpx required!

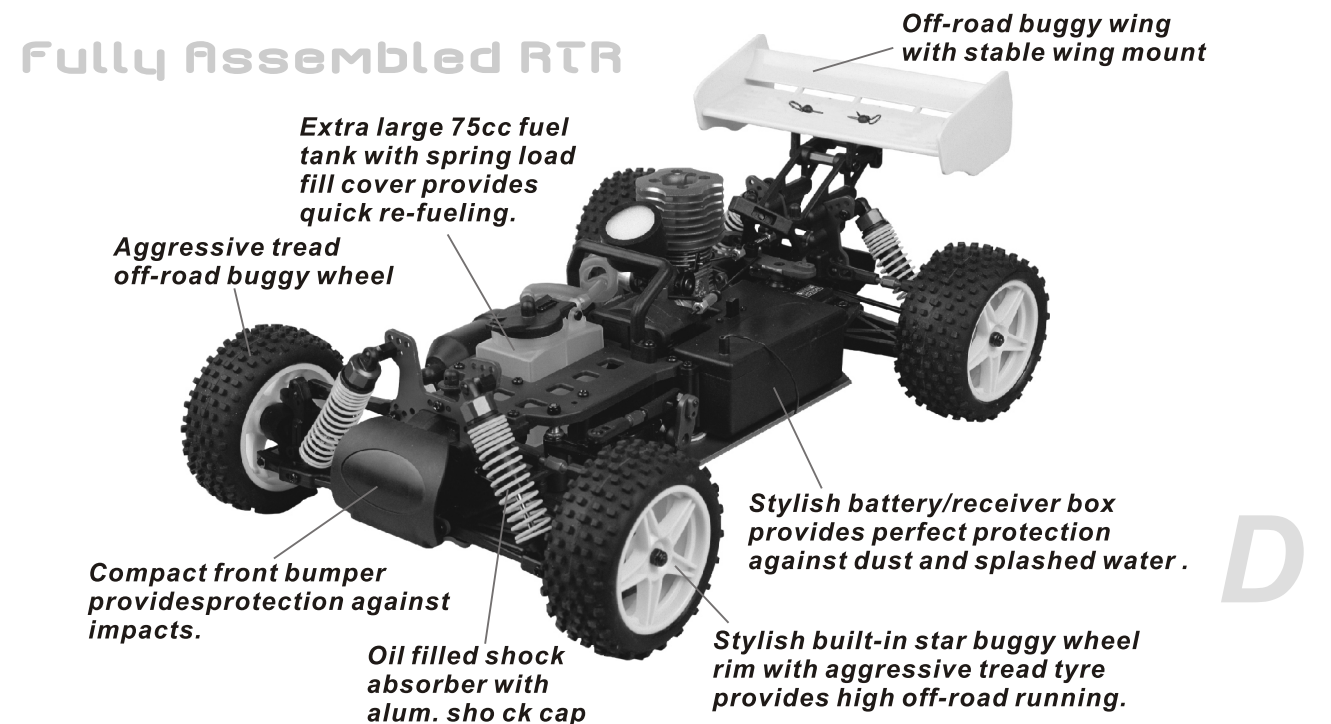

## Introducing Your Vehicle...

- **Large Capacity 75CC Leak Proof Fuel Tank With Overflow Pipe.**
- **Spring Loaded Fill Cover For Quick Re-fueling**
- **Front/rear Leakproof Differential With Metal Bevel Gears**
- **Lightweight Aluminium Flywheel 13.8g For Quick Engine Response**
- **Adjustable Oil Filled Shock Absorbers**
- **Differentials With 5 Screws Which Provide Quick Maintenance**
- **Powerful Disk Brake System With User Replaceable Pads**
- **Rigid 2.5 mm Anodized Aluminium Chassis**
- **High Flow Dual Foam Element Air Filter (\*User Serviceable)**
- **56 mm High Power Silencer And 7.5 mm Regulated Fuel Tank Vent**

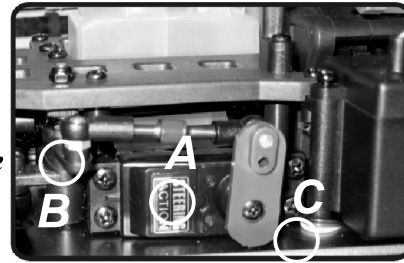

(A) Steering servo preforms quick steering response  
 (B) High quality servo saver assembly  
 (C) 2.5mm aluminum chassis

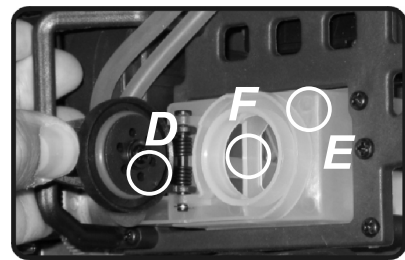

(D) Fuel tank seal cover with six holes can perform quick air vent and protect against dust/impurity.  
 (E) Extra large fuel tank with super calibre provides quick re-fueling  
 (F) Overflow/splash protection guard built in the fuel tank



(G) High quality 2-way gear built in compact gear box free from friction  
 (H) High performance brake discs  
 (I) 13.8g lightweight flywheel performs quick engine response.

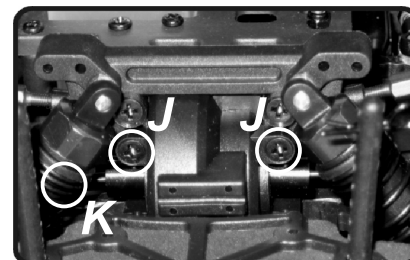

(J) Gear box with 5 adjustable screws provides quick maintenance.  
 (K) Good quality oil filled shock spring and aluminum shock cap provides powerful shock resistance.

## Before assembling or operating your model...

Carefully read and understand all instructions before operating the vehicle.  
 Correct adjustment of high speed needle and idle adjustment are required before operating your vehicle. Refer to carburetor adjustments before operating vehicle.  
 The following items(not included unless specified) are required to operate your vehicle and are available from your model dealer or the local hobby shop.

## Essential Items For Running Your Model

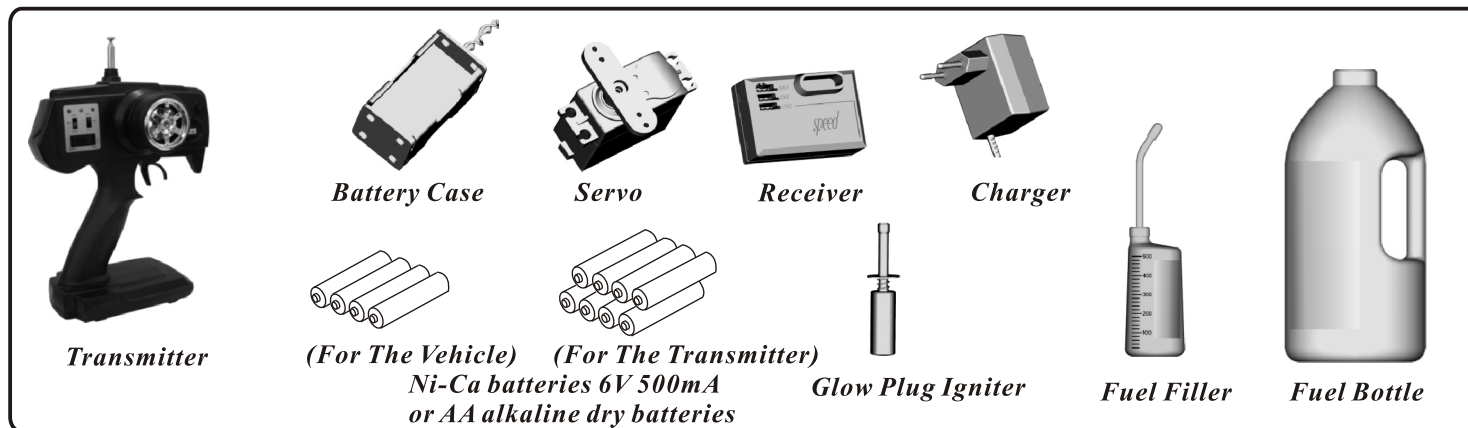

## Tools Required For Assembling Your Model

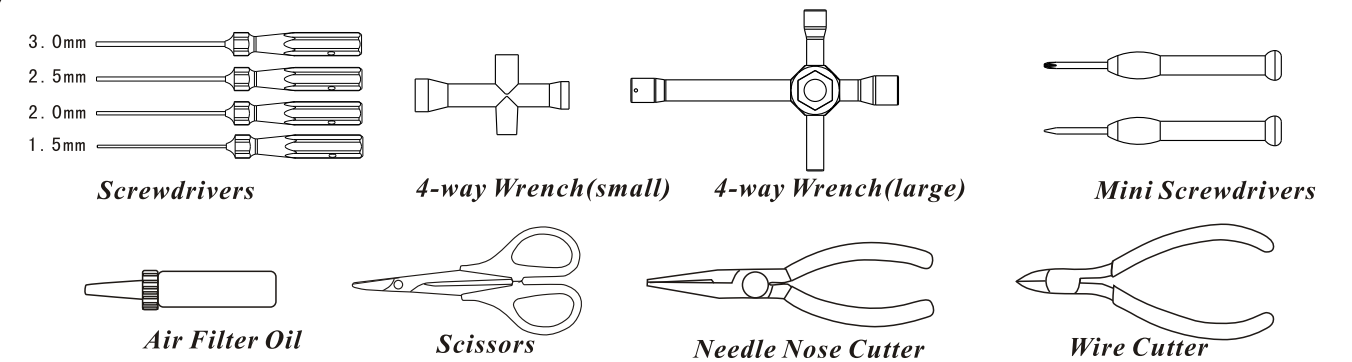

The following accessories at our shop are warmly recommended to you!

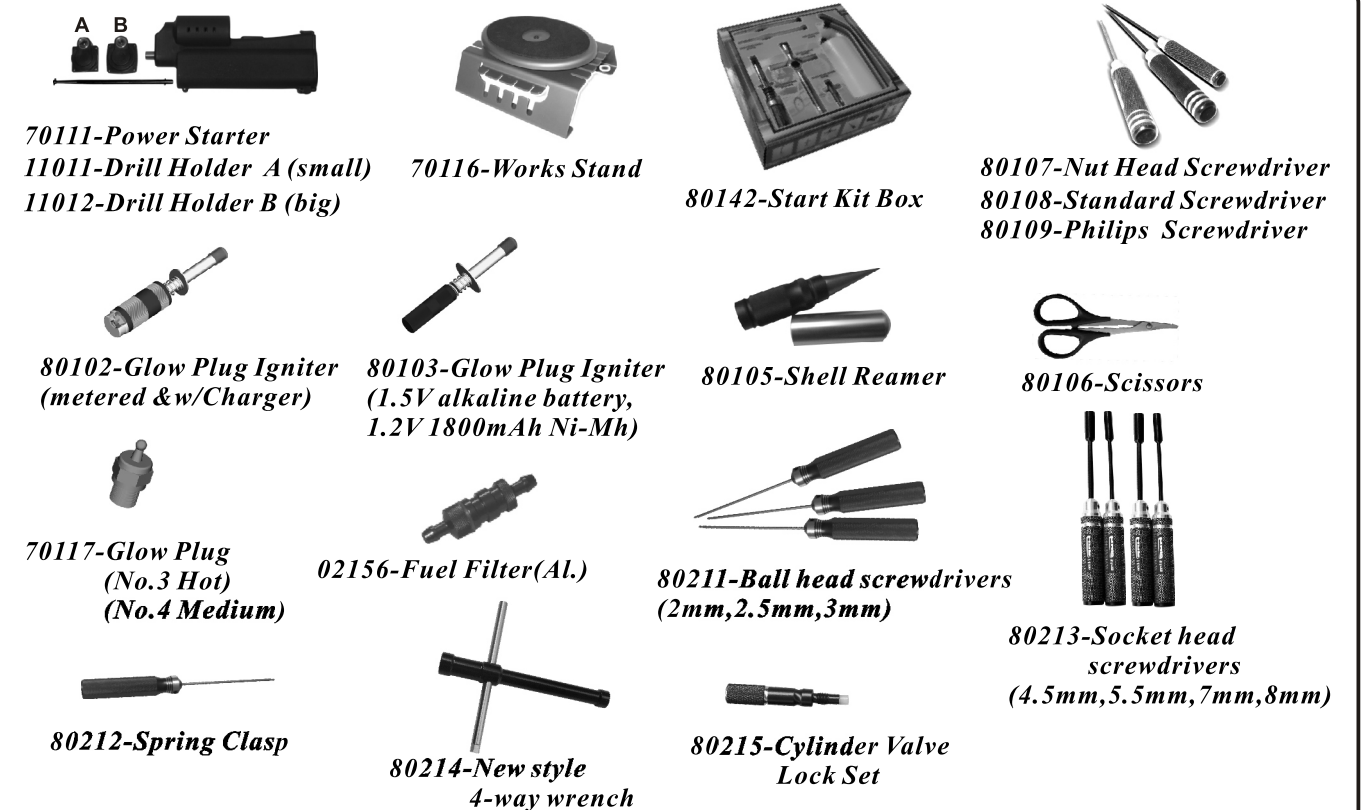

Note: Actual received tools may vary from the images!

## Use of transmitter to control your vehicle...

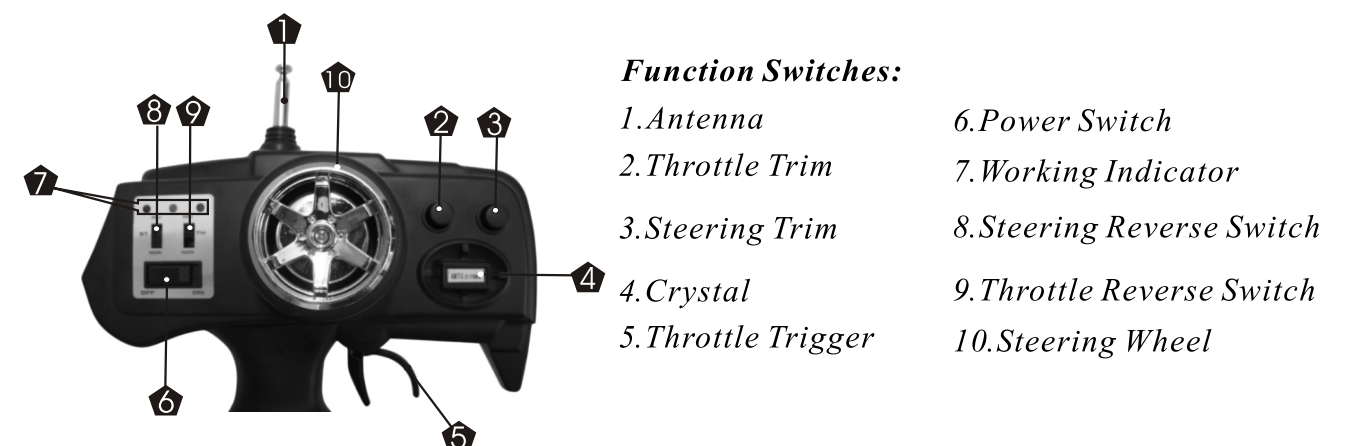

## Install the batteries to the transmitter

Insert the eight "AA" batteries into the battery compartment on the bottom of the transmitter.



← To open the battery door



To close the battery door →



### Battery Precautions:

1. In order to keep better performance, we warmly recommend you to use the 1.5V alkaline batteries instead of the 1.2 V chargeable batteries.
2. The batteries may leak in the event that they are installed with wrong polarities.
3. Do not use batteries of different types.
4. Do not mix old and new batteries.
5. Do not leave the batteries if not in use for long periods.

### Throttle Trigger

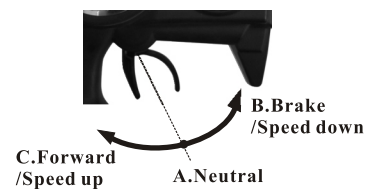

1. Push the trigger forwards to allow the vehicle to speed down to brake.
2. Pull the trigger backwards to allow the vehicle to go forward and speed up.

### Steering Wheel

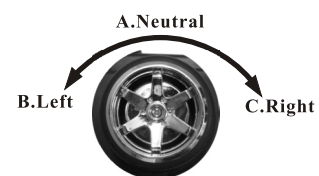

Turn the steering wheel to the left or right to let the vehicle turn left or right.

### Throttle/Steering Trim

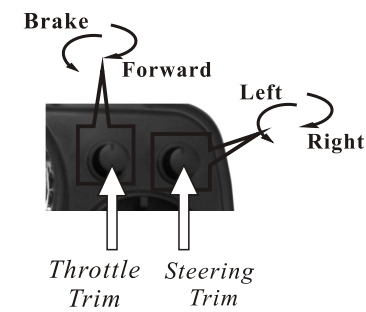

### Throttle Trim



Throttle Trim is used to slightly trim the throttle servo when the trigger is at Neutral position.

Steering Trim is used to slightly trim the front wheels steering.

Note: If the front wheels are not straight when the trigger is set at Neutral position you can adjust the steering trim to make them aligned.

Steering Reverse Switch  
Throttle Reverse Switch

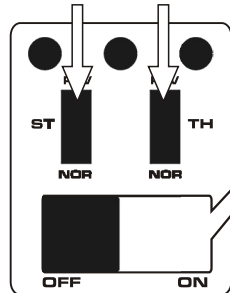

If you are a reverse operator, set the steering/throttle switch to REV. Position first.

## 2-Channel Radio System

Please read the following instructions before operating your vehicle.

Servos must be centered before operating. Performance of vehicle will be affected if this procedure is not completed.

To perform initial servo adjustment, rotate both trim controls on transmitter to center position.

Power on the transmitter then power on the receiver (switch is located on top cover)

Servos are now centered, linkage adjustment can now be completed.

Steering linkage: With trim knob at center position front wheels should point in a straight ahead.

If wheels point in either direction remove control horn from servo and center the wheels (along drive-line axis) replace control horn and observe corrections and re-adjust if necessary. Trim knob and servo are now centered, fine tuning of steering control can now be adjusted with steering trim knob on transmitter. Throttle/Brake linkage: With trim knob at center position, throttle will be closed. If carburetor linkage is open at center position remove control horn from servo and center the linkage, replace control horn and observe corrections and re-adjust if necessary.

Trim knob and servo are now centered, fine tuning of throttle control can now be adjusted with steering trim knob on transmitter.

Brake adjustment is performed via the thumb wheel on the end of the throttle linkage, brakes should not be applied at neutral position (vehicle must free-wheel when trigger is released)

Before operating your new engine please perform required break in procedure otherwise performance and durability of engine shall be compromised.

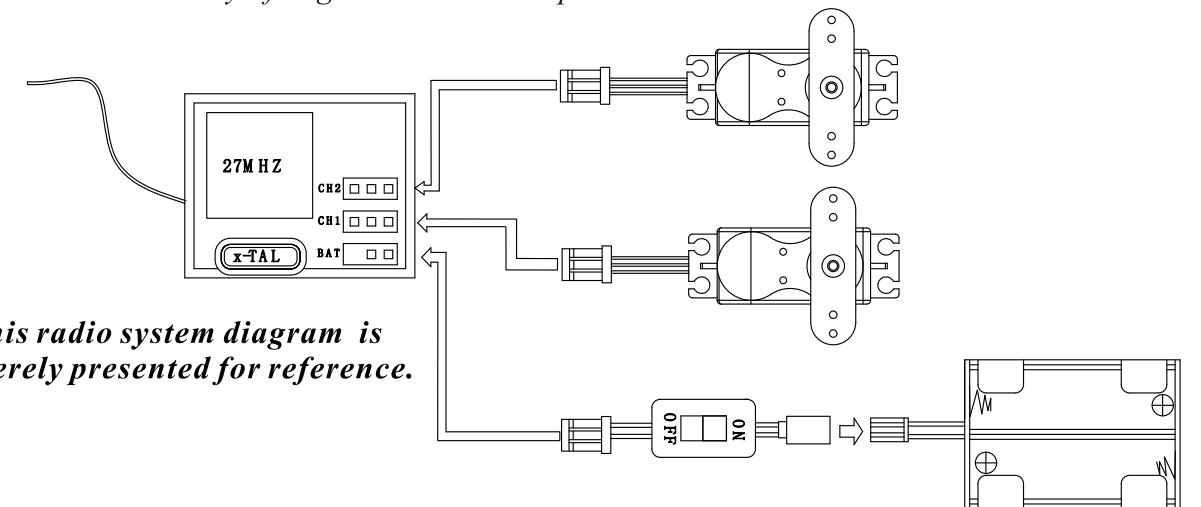

## Pre-Run Check

Please check your model before each driving.

### A Transmitter Switches

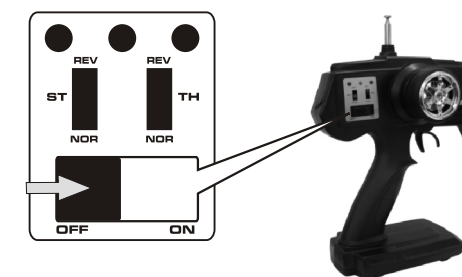
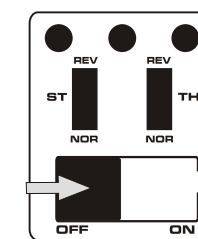

### Caution!

Make sure antenna is properly inserted and screwed in the transmitter. Antenna should be fully extended. Performance and control range of transmitter may be affected.

### B Chassis Switch

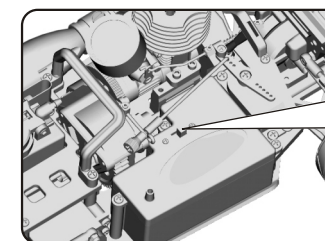

Turn on the switch on the chassis to activate radio system.

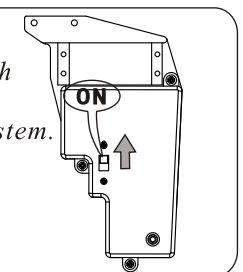

### C Check Steering Performance

Operate the steering wheel to check if the front wheels move correctly.

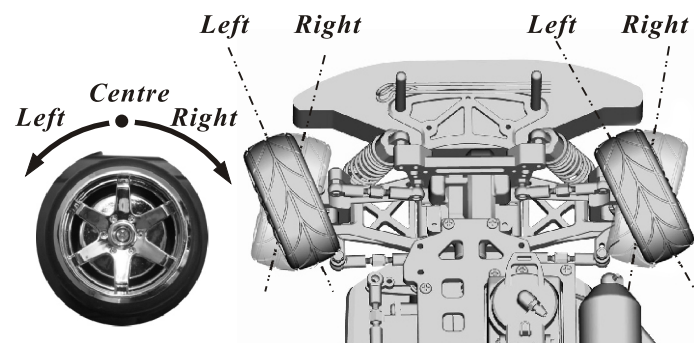

- ▶ The front wheel movement is controlled by the steering wheel.  
For instance: When moving the steering wheel to the left, the vehicle front wheels will also turn left.
- ▶ If the moving direction of the wheel is opposite to above mentioned, please change the Steering Reverse Switch position.

### D Steering Trim Setting

Gently lift up the front wheels while adjusting the steering trim.

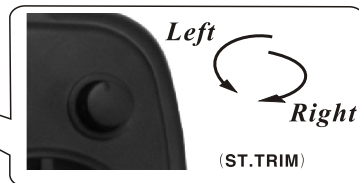
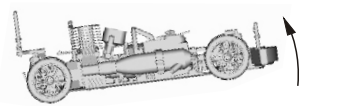

**Note:**  
Adjust the steering trim to center the front wheels of the vehicle when the steering wheel is at center position.

### E Throttle Trim Setting

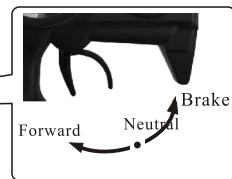

Perform throttle trim adjustment to provide quick/ smooth brake and running response!

### Engine View

Note: The actual received engine may vary from this image. The image is presented for your reference only.

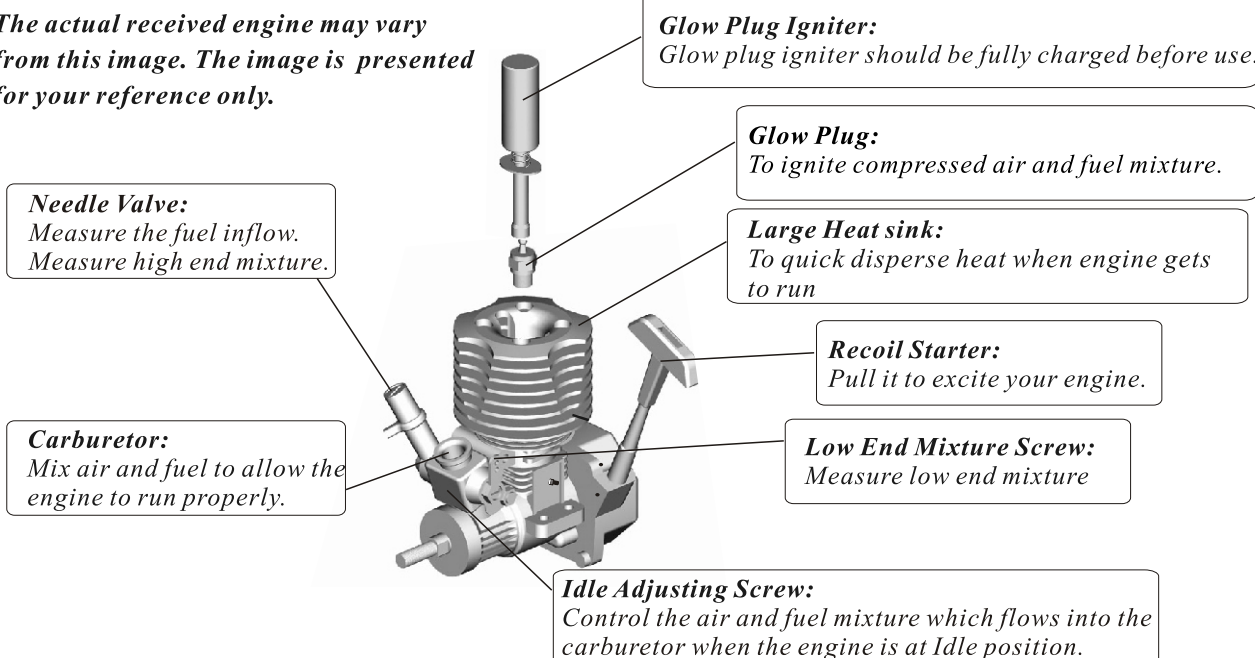

**Warning:** The engine includes many high-precision parts. The original performance may be reduced due to wrong operations or assembly and disassembly.

### Engine Break In

Many hobby type glow engines require a break in period to provide final adjustment of internal parts after manufacturing. This procedure is required and must be completed by you/the user. To prevent excessive initial wear on internal engine parts a rich air/glow fuel mixture is required to perform your engine break in.

#### Very important procedure must be followed !!

**Break-in period 2 and 1/2 turns from full closed position (4-5 tanks of 10-15% nitro/20% oil content) must be used to perform break in, do not run engine full throttle for long periods during break-in. Once break-in has been performed lean out engine to best performance (2 turns to 1 and 1/2 turns from full closed position) you must always observe a trace amount of oil smoke from tune-pipe, if you do not see any smoke stop immediately and re-adjust needle valve till smoke is observed.**

Always perform needle valve adjustment first, and then perform idle adjustment on a warmed-up engine. Environment conditions may require further adjustments.

Clean-out engine and exhaust system by applying high throttle (3/4 throttle) for 2 seconds after adjustment to permit effectiveness of adjustment to be observed.

We highly recommend replacing the engine " Glow Plug " (part # 70117) after you have completed the break-in.

It is of normal occurrence during the break-in that miniscule particles of metal adhere to the glow element. The particles of metal isolate the glow element and affect overall engine performance.

You may also be required to replace your glow plug during your break in procedure.

Normal nitro content: Once break-in has been performed 20% - 35%

Lubrication: We highly recommend a Premium glow fuel with a Synthetic/Castor blend of a minimum of 16% and maximum of 20% combined lubricant content.

### Engine Adjustment/Maintenance

#### 1. Needle Valve Adjustment

A. Start the engine to run your car

B. Keep an eye on the current running speed when the car is running straight with the throttle control set to High. The speed will go up when you screw in the needle valve at an angle of 10 or 20 degrees.

C. When continuing to screw the needle valve further in, the engine will become overheated and subject to damage. If it is the case, immediately unscrew the needle valve at an angle of 10 or 20 degrees to allow the engine to return to normal running.

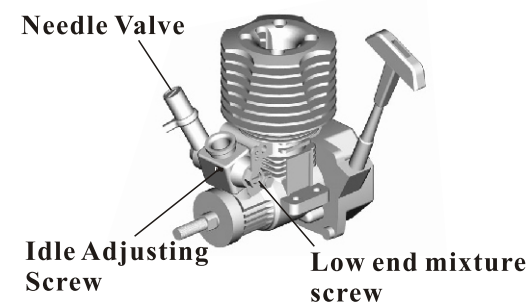

#### Acceleration from idle position.

Verify engine performance after start up. Pay close attention to exhaust smoke and engine sound.

Slow engine response is due to an over rich condition. Lots of smoke and popping sound from exhaust are observed.

Air and fuel mixture is too heavy. Screw in the needle valve at the angle of 30 degrees. (Clockwise)

Hesitation from idle to mid throttle is due to a lean condition. Almost no visible smoke is observed and engine may quit for no apparent reason.

Air and fuel mixture is too light. Unscrew in the needle valve at the angle of 30 degrees. (Anti-clockwise)

#### 2. Low end Adjusting Screw

Low end adjusting screw is used to trim the air and fuel mixture to flow into the carburetor.

#### 3. Idle Adjusting Screw

Idle adjusting screw is used to control the air and fuel mixture which flows into the carburetor when the engine is at Idle position.

## Engine Maintenance

1. Empty fuel tank and fuel lines before storing your vehicle.
2. Use premium "After Run Oil" this lubricant is utilised for storing of your engine  
Observe manufacturers instructions.
3. Remove all dirt and debris from vehicle with small brush (tooth brush) and/or with compressed air (observe proper personal security when operating air equipment)
4. Inspect and adjust all moving parts for excessive play, if adjustment cannot remove all excessive play observe part integrity and replace if required.
5. Correct lubrication of all bearings and moving mechanism is necessary for proper operation.
6. Disconnect and inspect batteries for leakage, recharge as required, do not store vehicle with batteries in unit for prolonged periods.
7. Operating radio controlled devices in wet/damp conditions is not suggested, vehicle may lose traction abruptly, and vehicle may be subject to water penetration in receiver compartment or in servos and loss of control of vehicle is imminent.

## To start the engine

### 1 Fill the fuel tank with fuel

Note: Actual received vehicle may vary from the images!

Note: Be extremely diligent in preventing fuel spill.

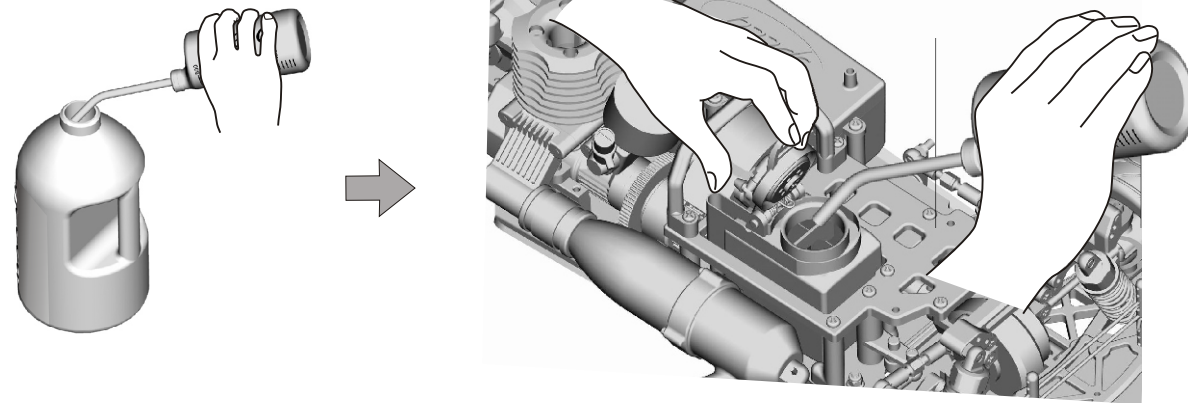

### 2 Switch on the transmitter, then the receiver.

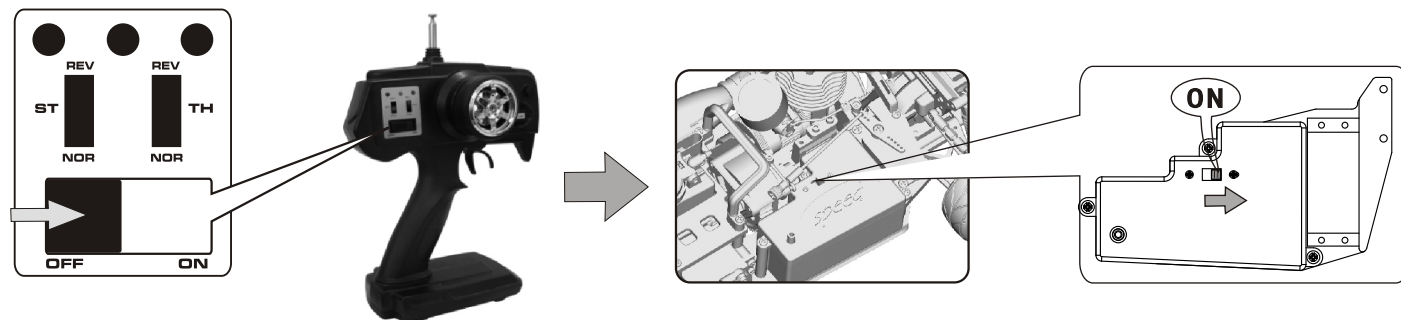

### 3 Remove the air filter.

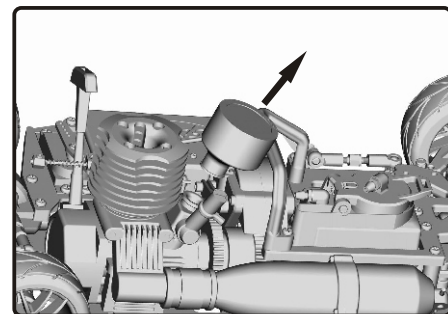

### 4 Open the throttle fully, and flow 2~3 drops fuel into the carburetor.

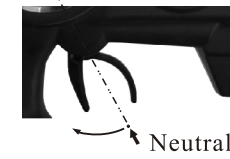

Pull the trigger back to reach the Full speed

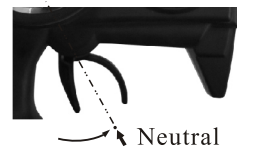
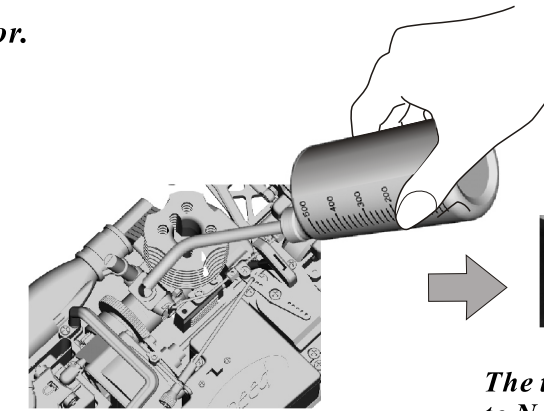

The throttle level returns to Neutral

### 5 Attach the air filter

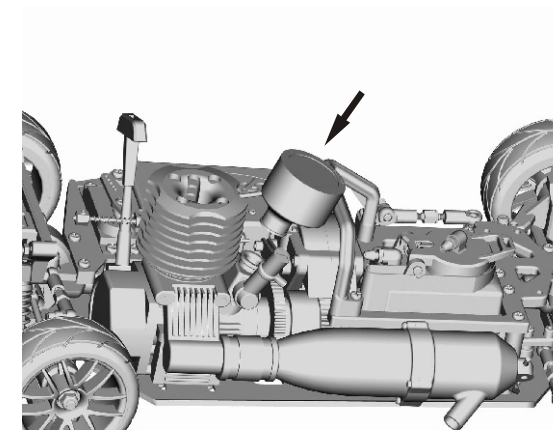

### 6 Use the glow plug igniter to excite the engine. If the glow plug igniter is short of power, please charge it before use.

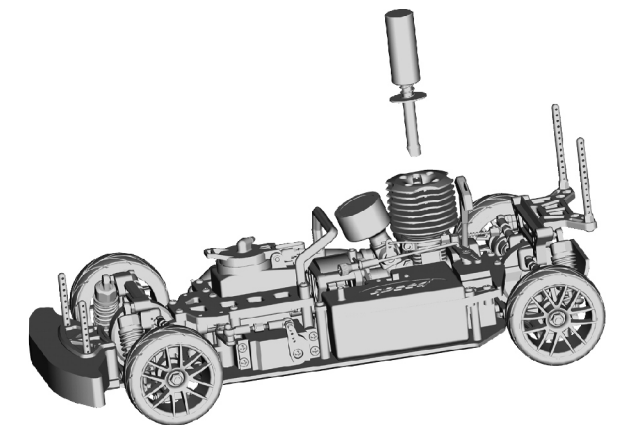

### 7 Hold the car securely while pulling the recoil starter cord.

## ! Caution!

To avoid engine damage, never force hard to crank engine, remove glow plug and ventilate engine by pulling the pull cord a few times. Install glow plug and try starting.

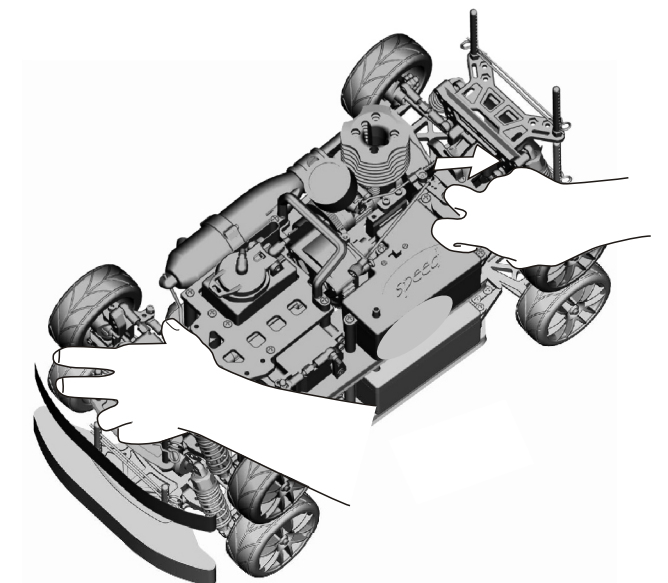

## Stop Running The Engine

1. Pinch fuel line with a peg to stop fuel from flowing into the engine.

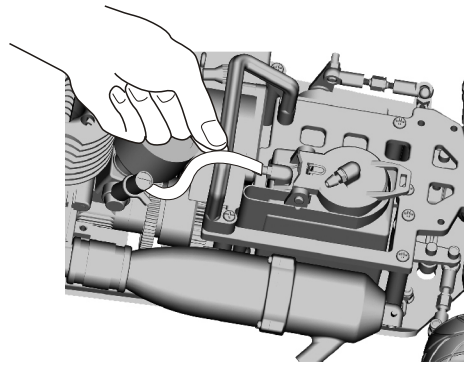

2. Turn off the receiver then the transmitter.

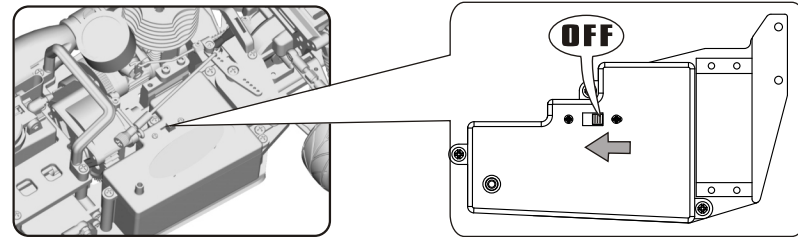

### WARNING

The engine, exhaust manifold and the tune-pipe are hot after running your vehicle and can burn your body. Do not touch any of these components immediately after running. Permit them to cool down first.

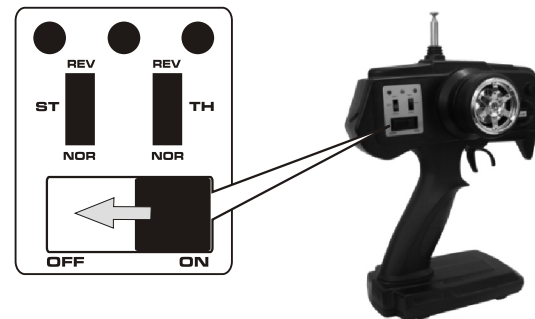

## ENGINE START TROUBLESHOOTING

If the engine fails to be started after the normal procedures are performed, please take it seriously and get down to the following:

- Verify that the approx. 0.5cc of fuel has flowed into the engine. The fuel that flowed into the engine should not be too heavy. Otherwise, the engine will become flooded and unable to function.
- Verify that a full-charged glow plug igniter is used. (If the glow plug can be excited and its pin subjects to turn red, it indicates that the glow plug igniter is of enough power. Please immediately charge it if necessary)

If the primed engine is still unable to be started by a full-charged glow plug igniter, you should perform the following procedures.

(The needle valve and/or the low end mixture screw had been properly calibrated at factory. However, you can perform some calibrations on them if necessary.)

1. Use the screwdriver to turn the needle valve and low end mixture screw tightly (clockwise), then unscrew them approx. 3 turns (anti-clockwise) to perform the correct calibration.

Note: Some hobby type glow engines have no the low end mixture screw. If it is the case, you are only required to unscrew the needle valve.

2. Ensure there is no wrong with fuel line and fuel route.

3. Before starting the engine, verify the glow plug igniter is of enough power and the good glow plug is used.

4. Use your fingers or a dry cloth to stifle the exhaust vent while pulling the recoil starter cord 5-6 times.

These actions will allow the fuel to flow into the engine.

(Note: Do not allow your fingers and body to touch the overheated engine and exhaust vent after the engine is started. Failure to do so will cause severe burns to your body)

5. Use the glow plug igniter to excite the engine while pulling the recoil starter cord several times until the engine start is observed.

## Troubleshooting no-start condition and engine performance.

### Probable causes

### Solutions

The engine is flooded.

Remove glow plug. Crank flooded engine several times to evacuate excess fuel. Do not place yourself over the glow plug hole, fuel may splash or flow when cranking.

### Engine can be cranked but will not start.

Is glow fuel reaching carburetor?

Add 2-3 drops of glow fuel directly in carburetor.

Is idle adjustment set properly?  
Remove air filter to verify.

Adjust opening with screwdriver. (1mm or 0.33")  
Replace air filter before starting.

Verify if glow plug is working.

If element does not glow verify glow stick.  
If in doubt replace glow plug.

### Miscellaneous

Cold outside temperature.

Screw in the needle valve at 60 degrees, and warm up the engine.

Engine is overheating.

Permit engine to cool down then gently unscrew the needle valve at 60 degrees and re-start up the engine.

Carburetor is blocked dirty.

Clean with automotive parts cleaner.

Air filter is blocking air passage.

Clean air filter element or replace air filter element.

Engine performance is affected.

Verify fuel lines, glow plug, adjustments and correct.

### Troubleshooting List

ISSUES	REASONS	SOLUTIONS
<b>THE ENGINE FAILS TO START.</b>	<ol style="list-style-type: none"> <li>1. The fuel tank is empty or the carburetor is not primed properly.</li> <li>2. The glow plug is bad or the batteries are dead.</li> <li>3. The fuel lines, the air filter, or the muffler is clogged.</li> <li>4. The engine is flooded.</li> <li>5. The carburetor is not adjusted properly.</li> <li>6. The servo linkage is not adjusted properly.</li> </ol>	<ol style="list-style-type: none"> <li>1. Fill the fuel tank up or prime the throttle.</li> <li>2. Replace the glow plug or charge the batteries.</li> <li>3. Clean or replace the clogged part(s).</li> <li>4. Remove the glow plug and discharge fuel.</li> <li>5. Set the Needle Valve/Low End Mixture Screw and the Idle Adjusting Screw to the Original position.</li> <li>6. Set the servo to Neutral then re-adjust it.</li> </ol>
<b>THE ENGINE CAN START BUT STALL IMMEDIATELY.</b>	<ol style="list-style-type: none"> <li>1. The fuel tank is empty.</li> <li>2. The fuel lines, the air filter, or the muffler is clogged.</li> <li>3. The carburetor is not adjusted properly.</li> <li>4. The engine is flooded.</li> </ol>	<ol style="list-style-type: none"> <li>1. Fill up the fuel tank.</li> <li>2. Clean or replace the clogged part(s).</li> <li>3. Re-adjust Idle Adjusting Screw and Needle Valve/Low End Mixture Screw.</li> <li>4. Allow the engine to thoroughly cool down and turn the Needle Valve open at the angle of 30 degrees.</li> </ol>
<b>POOR REACTION RESPONSE ON THE ENGINE.</b>	<ol style="list-style-type: none"> <li>1. The carburetor is not adjusted properly.</li> <li>2. Low fuel pressure level was found on the muffler.</li> </ol>	<ol style="list-style-type: none"> <li>1. Re-adjust Needle Valve/Low End Mixture Screw.</li> <li>2. Install the pressure line from the muffler to the fuel tank correctly.</li> </ol>
<b>THE VEHICLE BECOMES DIFFICULT TO CONTROL.</b>	<ol style="list-style-type: none"> <li>1. The batteries on the transmitter/receiver are weak.</li> <li>2. Radio antenna performs bad receptions.</li> <li>3. The servo linkage is not adjusted properly.</li> </ol>	<ol style="list-style-type: none"> <li>1. Replace or charge the batteries.</li> <li>2. Extend the transmitter antenna fully to obtain better receptions.</li> <li>3. Set the servo to Neutral then re-adjust it.</li> </ol>

# Shock Assembly

## On-road touring car shock assembly

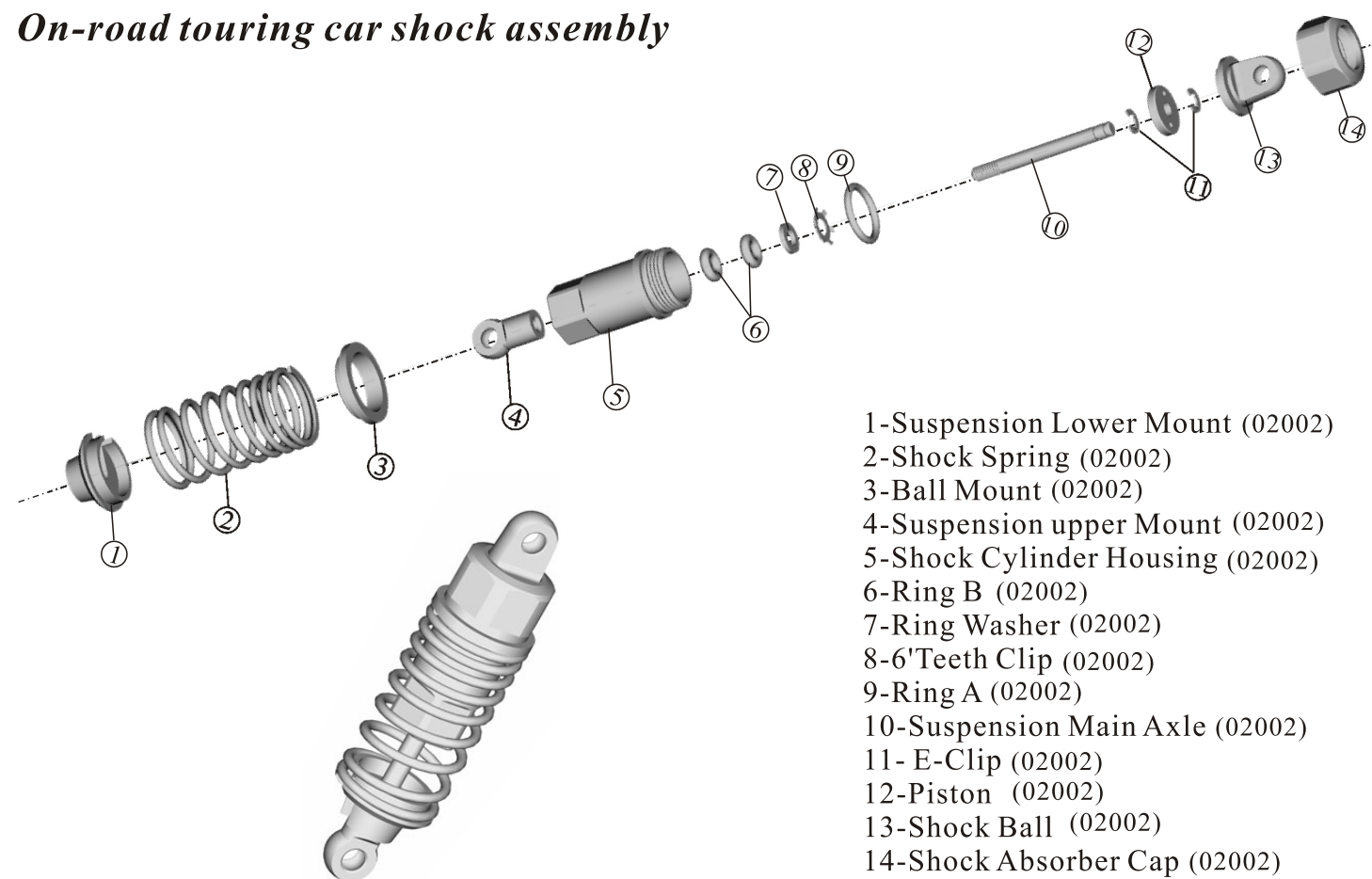

- 1-Suspension Lower Mount (02002)
- 2-Shock Spring (02002)
- 3-Ball Mount (02002)
- 4-Suspension upper Mount (02002)
- 5-Shock Cylinder Housing (02002)
- 6-Ring B (02002)
- 7-Ring Washer (02002)
- 8-6'Teeth Clip (02002)
- 9-Ring A (02002)
- 10-Suspension Main Axle (02002)
- 11- E-Clip (02002)
- 12-Piston (02002)
- 13-Shock Ball (02002)
- 14-Shock Absorber Cap (02002)

## Off-road buggy shock assembly

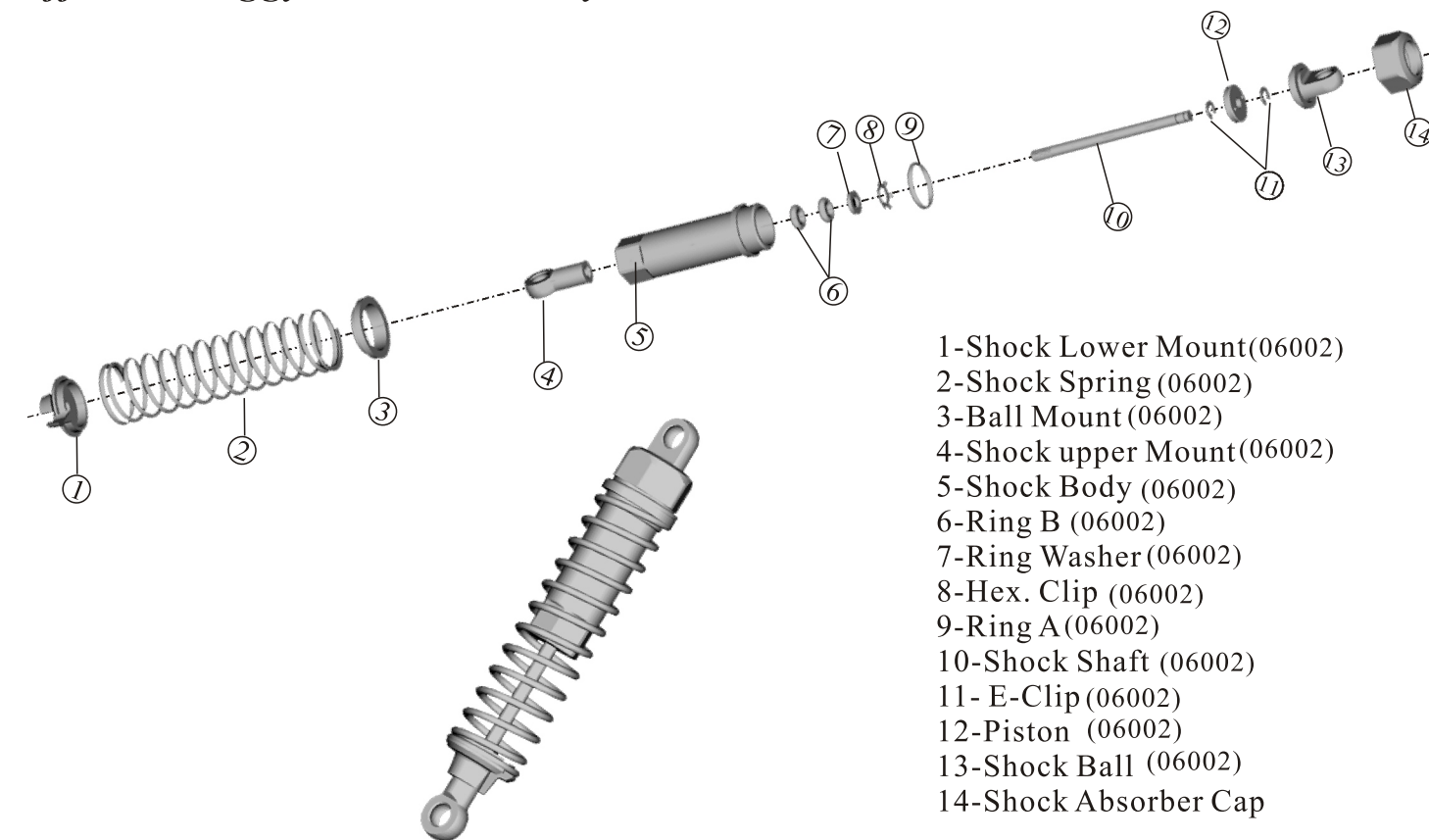

- 1-Shock Lower Mount(06002)
- 2-Shock Spring (06002)
- 3-Ball Mount (06002)
- 4-Shock upper Mount(06002)
- 5-Shock Body (06002)
- 6-Ring B (06002)
- 7-Ring Washer (06002)
- 8-Hex. Clip (06002)
- 9-Ring A(06002)
- 10-Shock Shaft (06002)
- 11- E-Clip(06002)
- 12-Piston (06002)
- 13-Shock Ball (06002)
- 14-Shock Absorber Cap

## Servo Saver/Steering Assembly

On-road touring car  
Off-road buggy

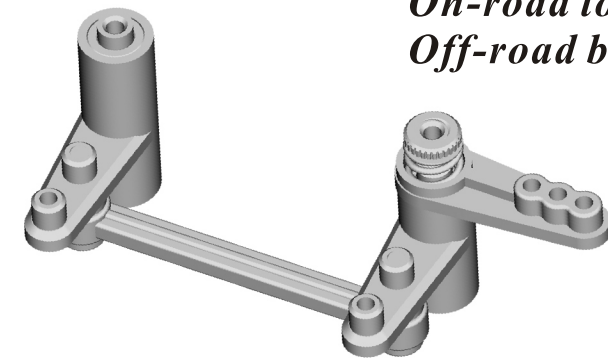
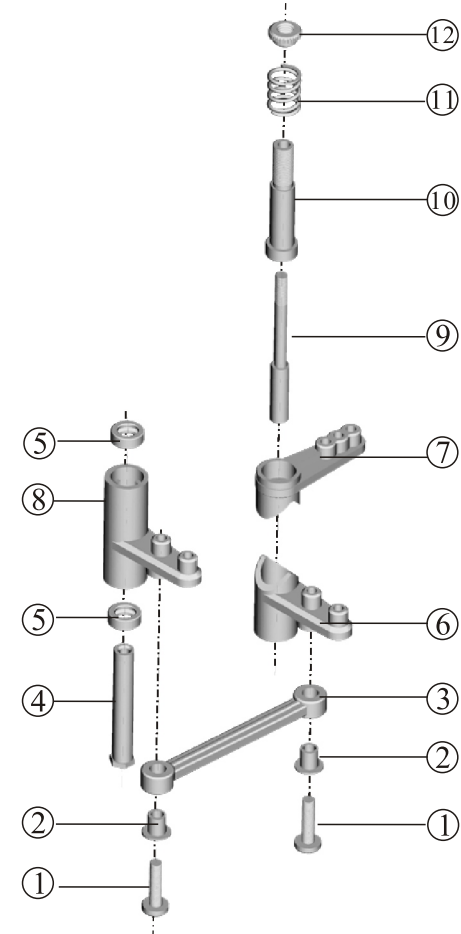

- 1-BT3\*14 BH Screw (02074)
- 2-Steering Joint Bushing (02074)
- 3-Steering Joint (02074)
- 4-Servo Pin Bushing A (02075)
- 5-Bearing  $\phi 8*5*3$  (02075)
- 6-Lower Servo Saver Bushing A(02025)
- 7-Upper Servo Saver Bushing A (02025)
- 8-Servo Pin Bushing B (02075)
- 9-Servo Saver Pin (02025)
- 10-Servo Saver Pin Mount (02025)
- 11- Servo Saver Spring (02025)
- 12-Adjustable Servo Saver Ring (02025)

## Exhaust Pipe

On-road touring car  
Off-road buggy

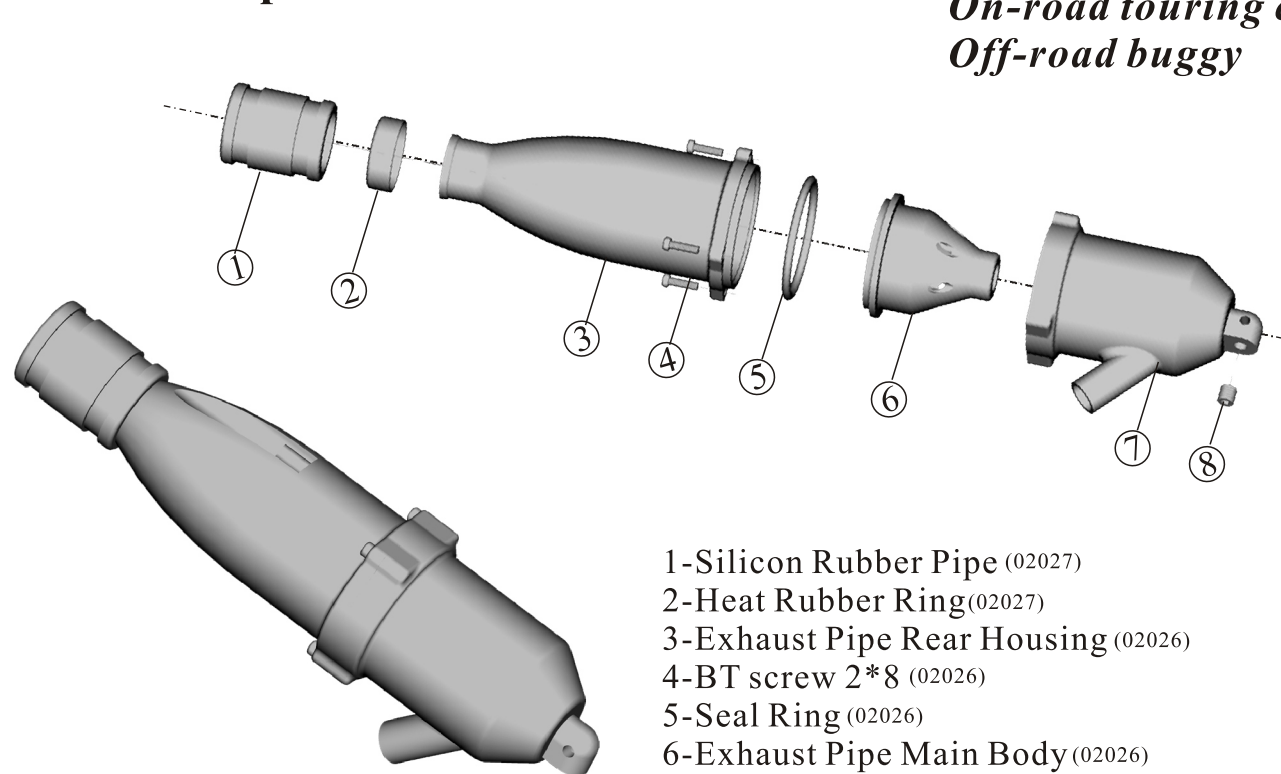

- 1-Silicon Rubber Pipe (02027)
- 2-Heat Rubber Ring(02027)
- 3-Exhaust Pipe Rear Housing (02026)
- 4-BT screw 2\*8 (02026)
- 5-Seal Ring (02026)
- 6-Exhaust Pipe Main Body (02026)
- 7-Exhaust Pipe Front Housing (02026)
- 8-M4\*4 Grub Screw (02026)



## Gear Box Assembly View

*On-road touring car  
Off-road buggy*

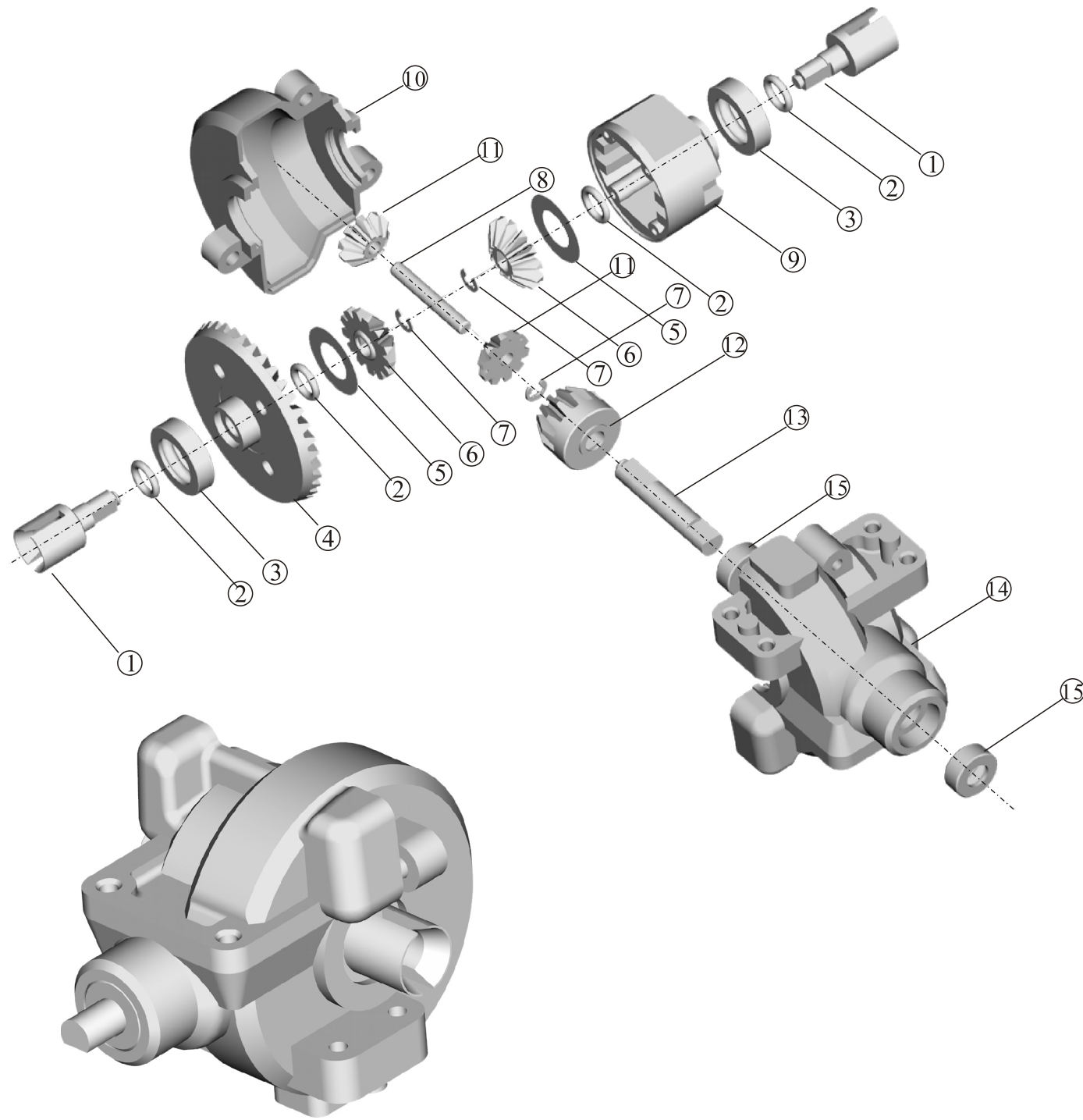

- 1- Universal Joint Cup C(02032)
- 2- O-ring(02078)
- 3- Rolling Bearing 15\*10\*4(02138)
- 4- Diff.Big Gear(02029)
- 5- Steel Washer(02039)
- 6- Diff. Big Gear(02066)
- 7- E-Clip  $\phi$  2.5(02037)
- 8- Diff. Pin 3\*24(02066)

- 9- Diff. Box(02039)
- 10-Gear box housing(front)(02051)
- 11-Diff. Small Gear(02066)
- 12-Drive Gear(02030)
- 13-Drive Shaft(02030)
- 14-Gear box housing(rear)(02051)
- 15-Rolling Bearing 10\*5\*4(02139)

## Single Speed Transmission System

*Single Speed Transmission On-road touring car  
Single Speed Transmission Off-road buggy*

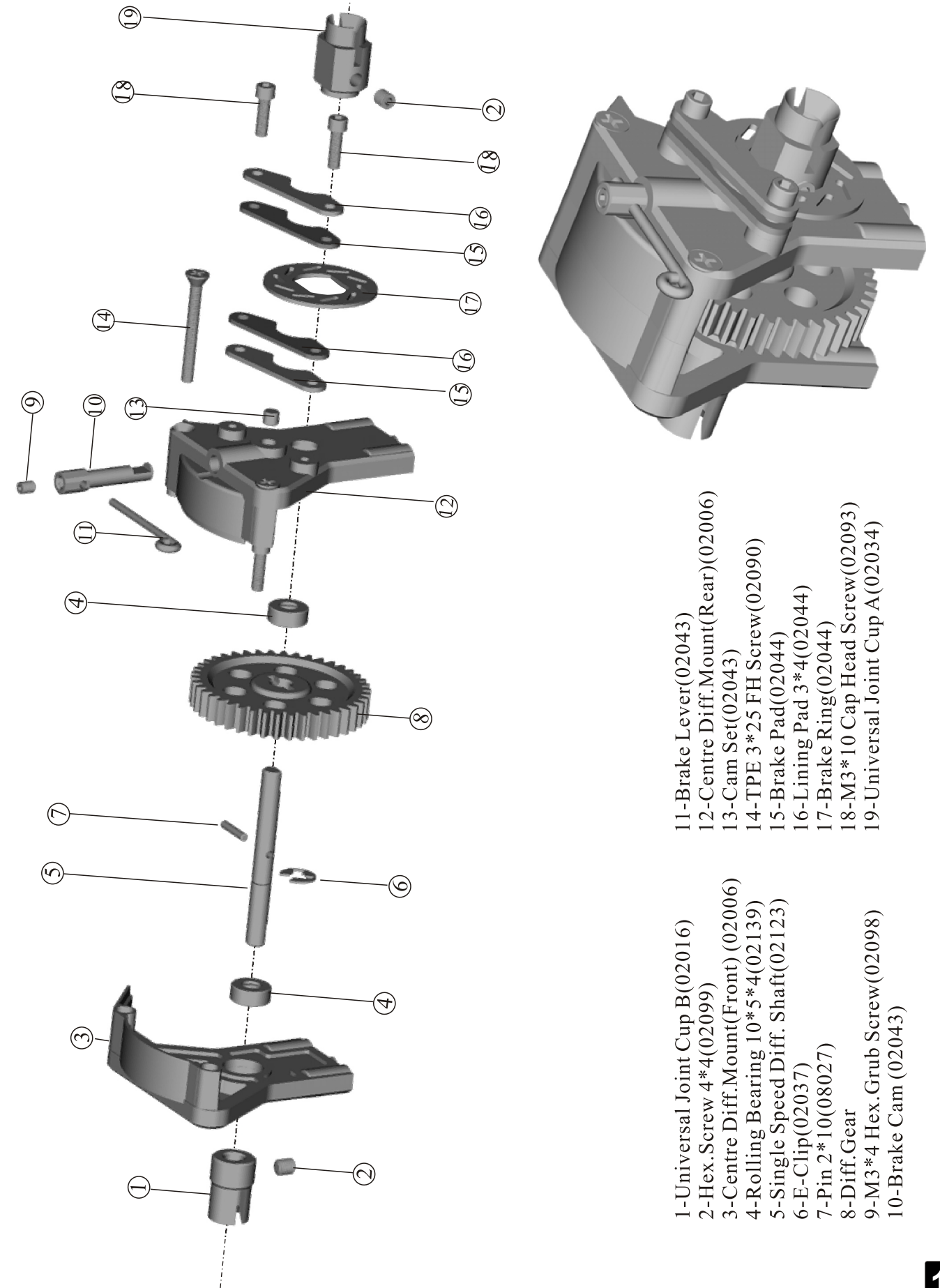

- 1-Universal Joint Cup B(02016)
- 2-Hex.Screw 4\*4(02099)
- 3-Centre Diff.Mount(Front) (02006)
- 4-Rolling Bearing 10\*5\*4(02139)
- 5-Single Speed Diff. Shaft(02123)
- 6-E-Clip(02037)
- 7-Pin 2\*10(08027)
- 8-Diff.Gear
- 9-M3\*4 Hex.Grub Screw(02098)
- 10-Brake Cam (02043)

- 11-Brake Lever(02043)
- 12-Centre Diff.Mount(Rear)(02006)
- 13-Cam Set(02043)
- 14-TPE 3\*25 FH Screw(02090)
- 15-Brake Pad(02044)
- 16-Lining Pad 3\*4(02044)
- 17-Brake Ring(02044)
- 18-M3\*10 Cap Head Screw(02093)
- 19-Universal Joint Cup A(02034)

# Two Speed Transmission System

*Two Speed Transmission On-road touring car*  
*Two Speed Transmission Off-road buggy*

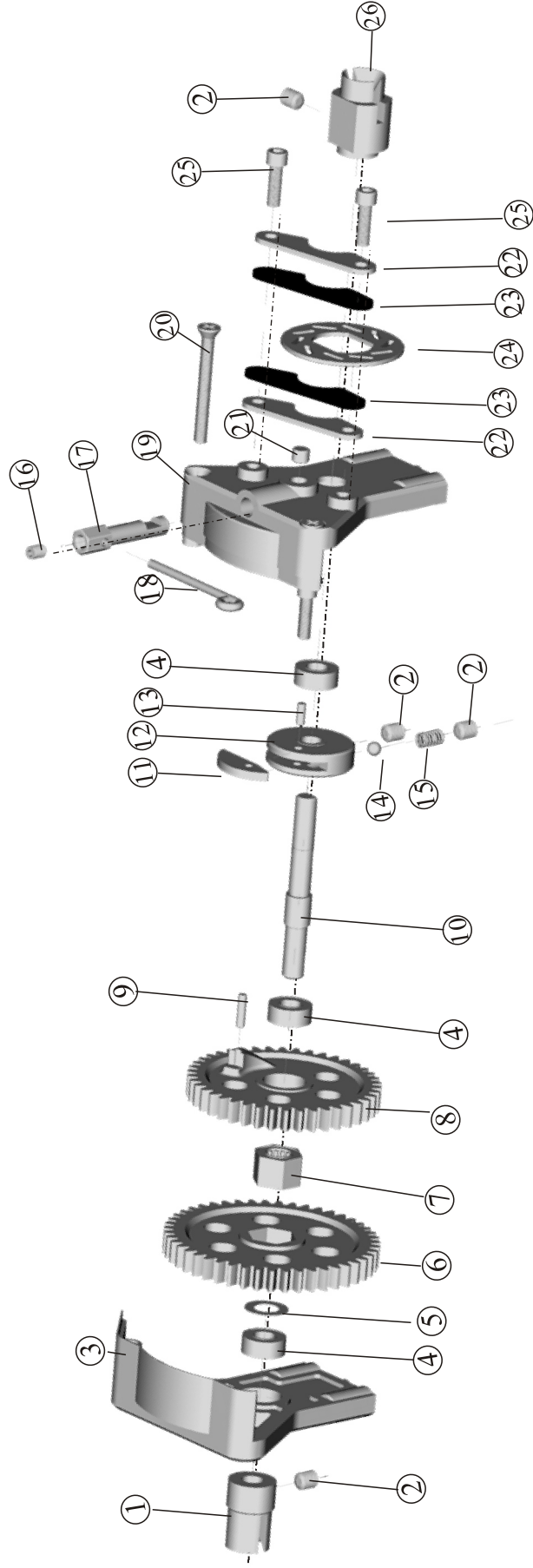

- 1-Universal Joint Cup B(02016)
- 2-Hex.Screw 4\*4(02099)
- 3-Centre Diff. Mount (front) (02006)
- 4-Rolling Bearing 10\*5\*4(02139)
- 5-Washer  $\phi$  10\*5\*4
- 6-Buggy Spur Gear(42T)/On-road car Spur Gear(39T)
- 7-One-Way Hex. Bearing(02067)
- 8-Buggy Spur Gear(47T)/On-road car Spur Gear(44T)
- 9-Pin 2\*8
- 10-Two Speed Diff. Shaft (02054)
- 11-Clutch Shoe Holder(02045)
- 12-Clutch Body Housing(02045)
- 13-Pin 2\*5(02045)
- 14-Clutch Bead(02045)
- 15-Spring(02045)

- 16-Hex.Screw 3\*4(02098)
- 17-Brake Cam (02043)
- 18-Brake Lever(02043)
- 19-Centre Diff.Mount (Rear)(02006)
- 20-TPE3\*25 FH Screw(02090)
- 21-Cam Set(02043)
- 21-Brake Pad(02044)
- 22-Lining Pad(02044)
- 23-Brake Ring (02044)
- 25-M3\*10 Cap Head Screw(02093)
- 26-Universal Joint Cup A(02034)

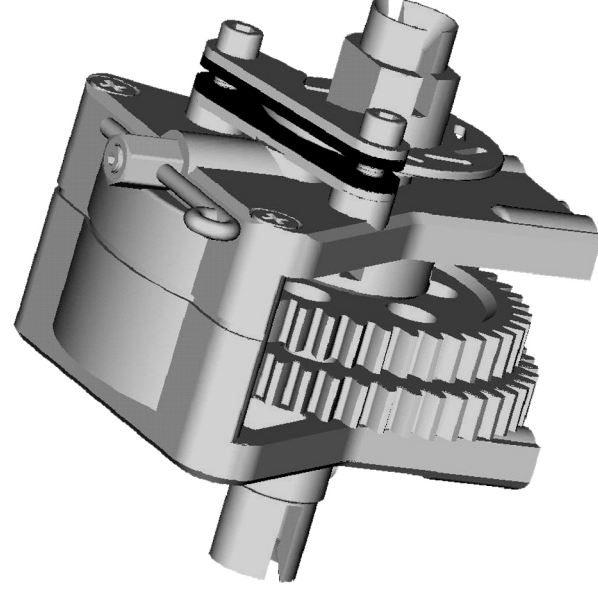

## 18CXP ENGINE ASSEMBLY DIAGRAM

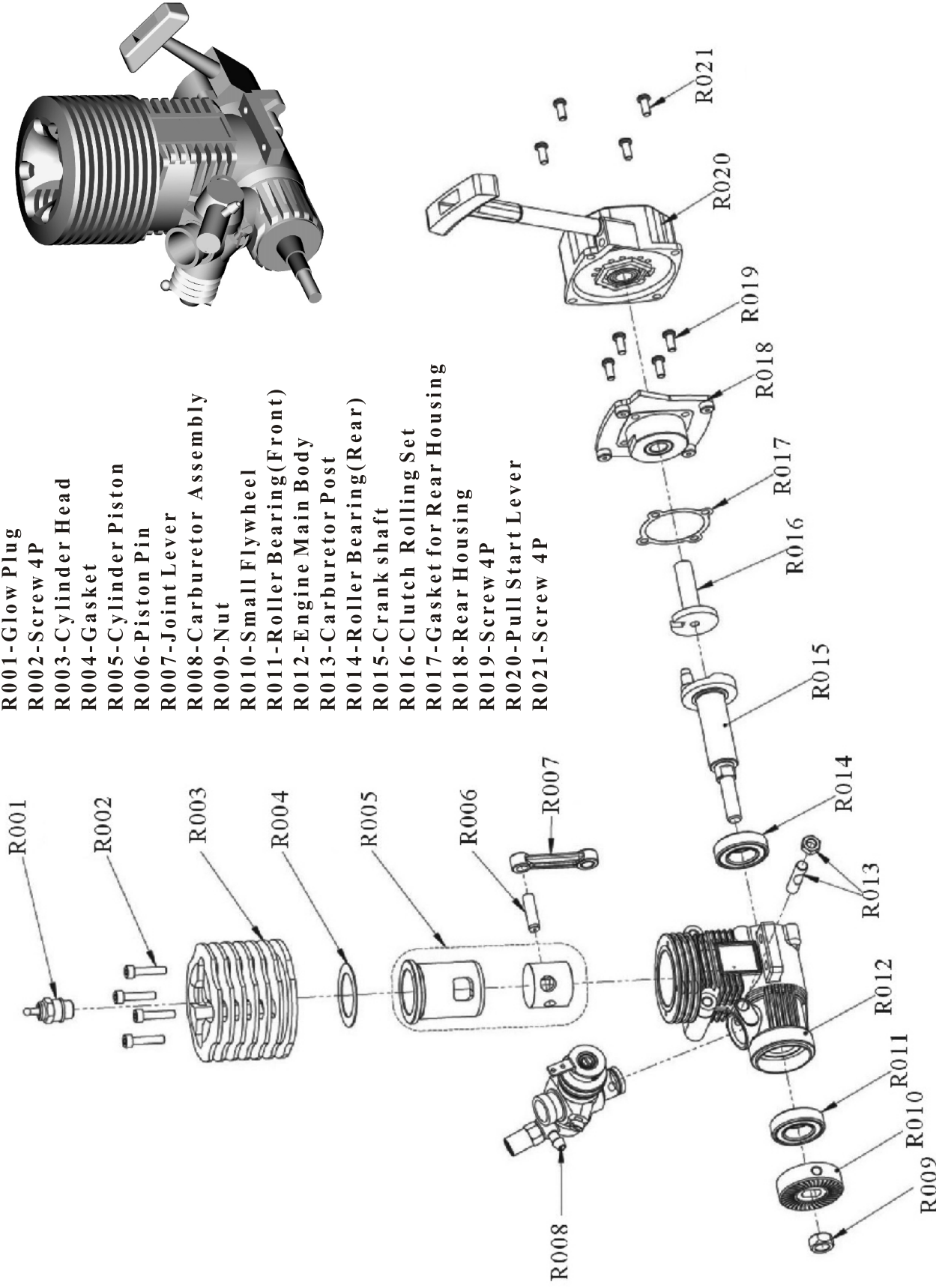

- R001-Glow Plug
- R002-Screw 4P
- R003-Cylinder Head
- R004-Gasket
- R005-Cylinder Piston
- R006-Piston Pin
- R007-Joint Lever
- R008-Carburetor Assembly
- R009-Nut
- R010-Small Flywheel
- R011-Roller Bearing(Front)
- R012-Engine Main Body
- R013-Carburetor Post
- R014-Roller Bearing(Rear)
- R015-Crankshaft
- R016-Clutch Rolling Set
- R017-Gasket for Rear Housing
- R018-Rear Housing
- R019-Screw 4P
- R020-Pull Start Lever
- R021-Screw 4P









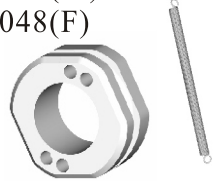
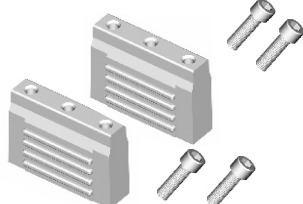
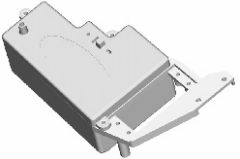
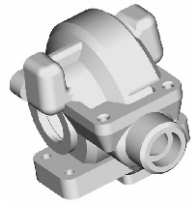
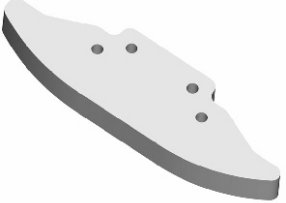
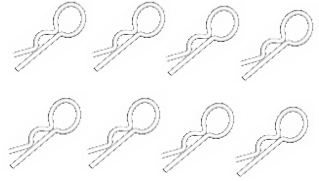

**Spare Parts-1**

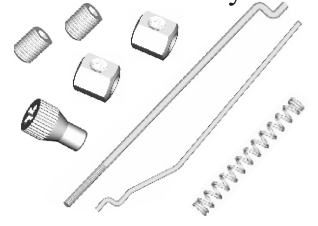
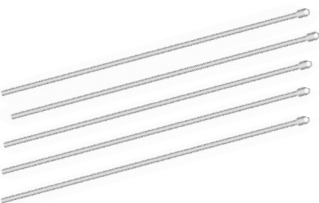
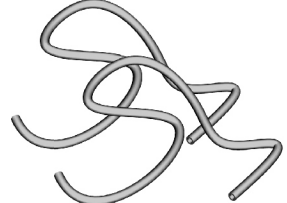
02001-Chassis 	02002-On-road Car Shock Absorber 2P 	02003- Front Dog bone /Centre F/R Dog bone 2P Hole track:55mm Total length:61mm 	02003T-Rear Dog bone 2P Hole track:54.5mm Total length:60mm 
02004-Fuel Tank 	02005-Rear Bumper 	02006-Centre Diff. Mount 	02007-Rear Lower Suspension Arm 2P 
02008-Front Lower Suspension Arm 2P 	02009-Front Bumper Top Plate 	02010-Body Post 4P 	02011-Handle 
02012-Steering Servo Link /Front &Rear Upper Link 2P 	02013-Rear Upright (L/R)/Grub screws 2P 	02014-Steering Hub (L/R) 	02015-Front Hub Carrier(L/R) 
02016-Universal Joint Cup B/Set Screws 2P 	02017-Suspension Arm Brace 2P 	02018-Parallel Six Spoke Wheel Rim 2P 	02019-V-tread On-road Racing Car Tyre 2P 
02020-Wheel Complete 2P (02018+02019) 	02021-Rear Suspension Arm Bottom Mount 	02022-Front Suspension Arm Bottom Mount 	02023-Clutch Bell (Double gears)  <b>Two Speed Required!</b>

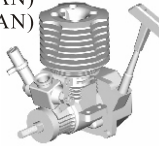
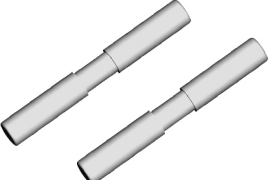
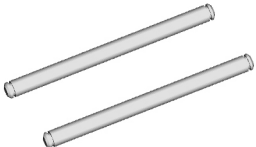
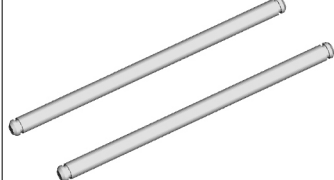

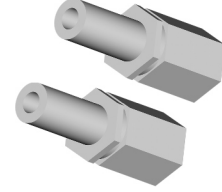
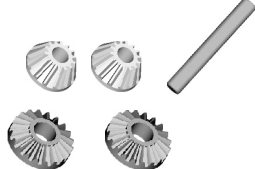

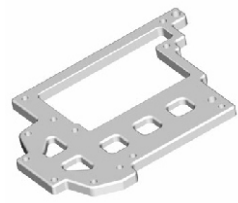
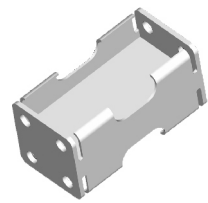

**Spare Parts-2**

02024-Diff. Gear Complete 	02025-Servo Saver Arm Complete A 	02026-Exhaust Pipe 	02027-Exhaust Silicon Rubber Pipe/Heat Rubber Tube 
02028-Air Filter w/Sponge 	02029-Diff.main gear 	02030-Drive Gear 	02031-Exhaust Manifold 
02032-Universal Joint Cup C 	02033-Axle 	02034-Universal Joint Cup A 	02035-Front Shock Tower 
02036-Front Lower Shaft Pin A 2P 	02037-E-Clip 12P (Φ7. Φ4.Φ2.5.Φ2.3) 	02038-Ball Head Screw 6P 	02039-Diff.Case (w/two rings & steel washers) 
02040-Diff. Main Gear (44 T) <i>For Two Speed Transmission!</i> 	02041-Diff.Main Gear (39T) <i>For Two Speed Transmission!</i> 	02042-Rear Shock Tower 	02043-Cam Shaft 
02044- Disc Brake 2P 	02045-Two-Way Drive Clutch 	02046-Radio Tray Post A 	02047-Radio Tray Post B 

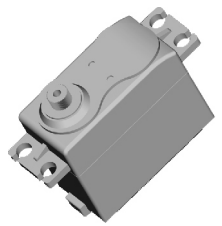
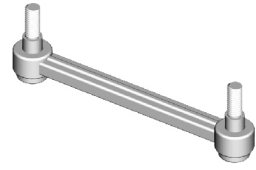
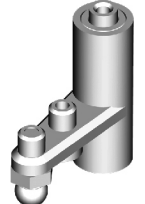
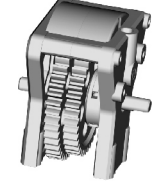
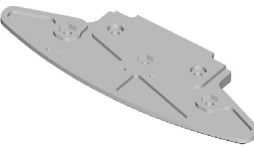
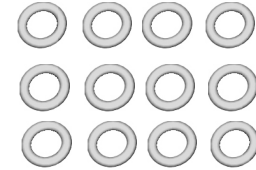
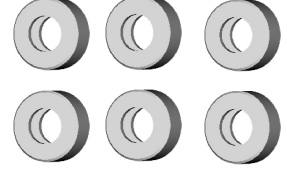
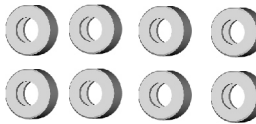
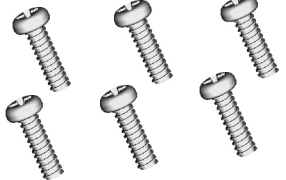
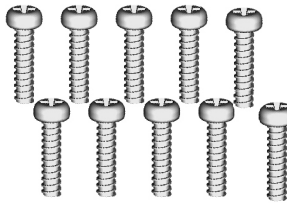
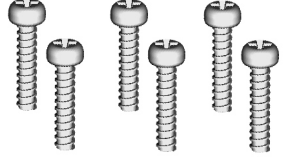
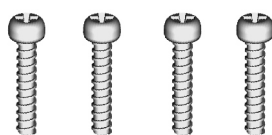
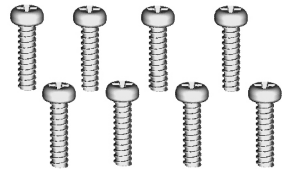
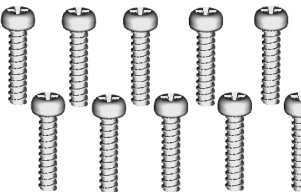

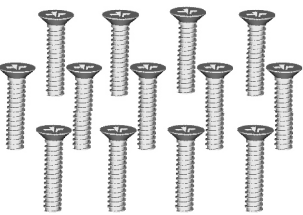

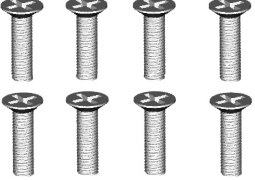
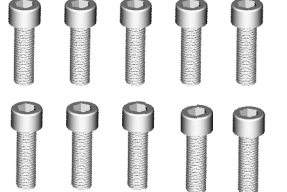
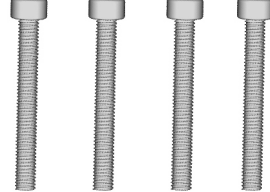

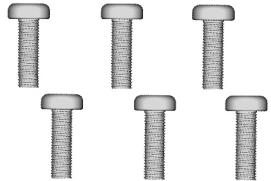

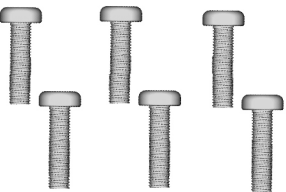
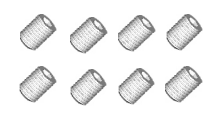
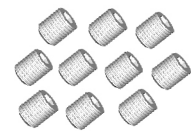
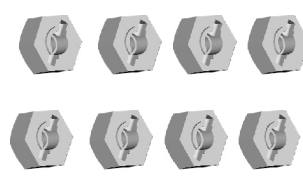
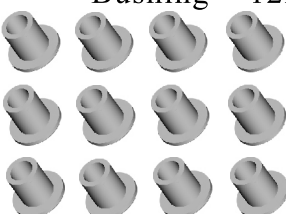

**Spare Parts-3**

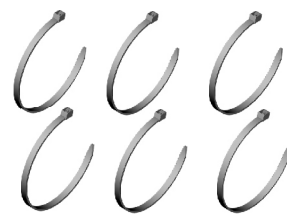
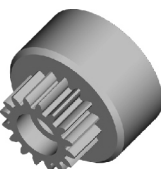
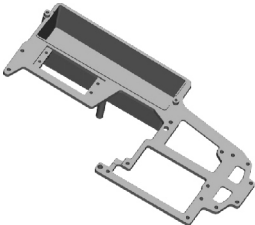
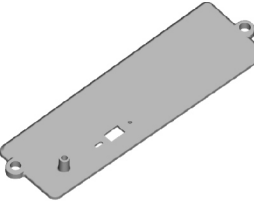
02048-Clutch Shoe(w/ Spring) 02048(M) 02048(F) 	02049-Engine Holder w/Cap Head Screws 	02050-Battery/ Receiver Case 	02051-Gear Box 
02052-Front Bumper Foam 	02053-Body Clip 8P 	02054-Two Speed Transmission Gear Post 	02055-Nylon Nut M4 
02056-Throttle/Brake Assembly 	02057-Antenna Pipe 4P 	02058-Fuel Tube 2P 	02059-Exhaust Pipe Holder w/Cap Screw&Nut 
02060-Engine 01-12CXP(TAIWAN) 02-15CXP(TAIWAN) 03-16CXP(TAIWAN) 04-18CXP(TAIWAN) 05-16CXP(JAPAN) 06-18CXP(JAPAN) 	02061-Rear Lower Arm Round Pin B 2P 	02062-Front Lower Arm Round Pin B 2P 	02063-Rear Lower Arm Round Pin A 2P 
02064-Rear Body Post Support Plate 	02065-Flywheel Pilot Post 2P 	02066-Diff. Pinions+ Bevel Gears+Pin 	02067-One Way Hex. Bearing 
02068-Engine Flywheel 	02069-Radio Tray 	02070-Battery Compartment 	02071-Receiver 

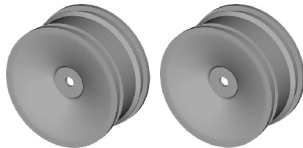

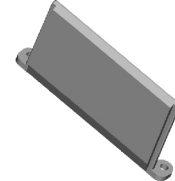
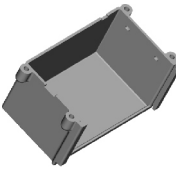
**Spare Parts-4**

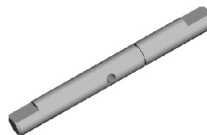
02072-Servo Arm 2P  <i>Image may vary from actual unit.</i>	02073-Servo Unit 	02074-Steering Set Bottom Joint 	02075-Steering Arm Complete B 
02076-Two Speed Transmission Complete  <b>Two Speed Required!</b>	02077-Front Bumper Foam Holder 	02078-O-Ring 12P 	02079-Oil Bearing $\phi 15*\phi 10*4$ 6P 
02080-Oil Bearing $\phi 5*\phi 10*4$ 8P 	02081-BT3*8 BH Screw 6P 	02082-BT3*10 BH Screw 10P 	02083-BT3*12 BH Screw 6P 
02084-BT3*18 BH Screw 4P 	02085-BT2*8 BH Screw 8P 	02086-BT2*10 BH Screw 10P 	02087-TPE3*10 FH Screw 15P 
02088-TPE3*14FH Screw 13P 	02089-TPE3*15FH Screw 9P 	02090-TPE3*25FH Screw 4P 	02092-ISO 3*10 Screw 8P 
02093-M3*10 Cap Head Screw 10P 	02094-M3*28 Cap Head Screw 4P 	02095-M3*8 Cap Head Screw 4P 	02096-3*10 Cap Head Screw 6P 

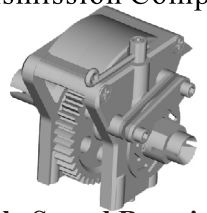
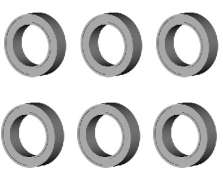
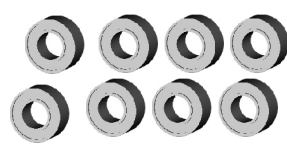
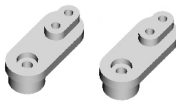
**Spare Parts-5**

02097-3*14 Cap Head Screw 6P 	02098-M3*4 Grub Hex. Screw 8P 	02099-M4*4 Grub Hex. Screw 10P 	02100-Wheel Hex. 8P 
02101-Steering Plate Bushing 12P 	02102-Nylon Nut M3 6P 	02103-Zip Tie 6P 	02107-Clutch Bell (Single Gear)  <b>Single Speed Required!</b>
02110-Radio Tray 	02111-Battery Cover 	02112-Diff. Gear (42 teeth) <i>For Single Speed Transmission!</i>  <b>Single Speed Required!</b>	02113-Sealed Wheel Rim 
02116-Diamond Tread On-road Racing Car Tyre 2P 	02117-Wheel Complete 	02118-Receiver Side plate 	02119-Receiver Holder 
02121-Allen Screw 3*10 2P 	02127-Allen Screw 3*12 2P 	02123-Single Speed Shaft 	02125-Battery Board 
02126-Single Speed Transmission Complete  <b>Single Speed Required!</b>	02138-Ball Bearing 15* 10*4 6P 	02139-Ball Bearing $\phi 10*\phi 5*4$ 8P 	02372-Steering Servo Arm 2P 

**Spare Parts-6**

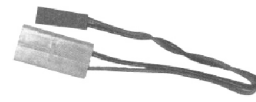
02108A-Front Anti Roll Bar Assembly <i>Optional use unless ordered</i> 	02108B-Rear Anti Roll Bar Assembly <i>Optional use unless ordered</i> 	03027-Charger/Battery Wire Connector <i>Optional use unless ordered</i> 	
--	---	---	--

**Wheel rims/Tyres/ Wheels complete(Optional)**

We offer other different style wheel rims and wheel complete for our on-road racing cars!

02228-Star Style Spoke Wheel Rim 2P 	02185-Wheel Complete (02116+02228) 2P 	02018N-Ten Spoke Wheel Rim 2P 	
--	--	--	--

**Optional Parts-1**







**HOPS-UP**

02115-Radio/Fuel Tank Tray  NEW NO.:102002	02114-Aluminum Shock Absorber 2P  NEW NO.:102004	02128-Aluminum Engine Mount 2P  NEW NO.:102005	02124-Aluminum Exhaust Pipe  NEW NO.:102009
02132-Aluminum Front Hub Carrier (L/R)  NEW NO.:102010	02131-Aluminum Steering Hub(L/R)  NEW NO.:102011	02130-Aluminum Rear Hub Carrier (L/R)  NEW NO.:102012	02106-Universal Drive Joint 2P  NEW NO.:102015
02157-Aluminum Front/rear & Servo Link 2P  NEW NO.:102017	02161-Aluminum Front Lower Arm 2P  NEW NO.:102019	02160-Aluminum Rear Lower Arm 2P  NEW NO.:102021	02158-Aluminum Front Shock Tower  NEW NO.:102022
02159-Aluminum Rear Shock Tower  NEW NO.:102023	02144-Aluminum Body Post 4P  NEW NO.:102037	02134-Aluminum Wheel Hex. Mount 4P  NEW NO.:102042	02191-Aluminum Nut M3 8P  NEW NO.:102048
02190-Aluminum Nut M4 4P  NEW NO.:102049	02156-Aluminum Fuel Filter 	02031A-Polished Aluminum manifold+ Pad 	102057-Alum. Steering Servo Saver Complete ★ 

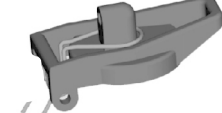
The images with ★ are still undeveloped and will come in near future.

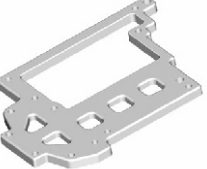

**Optional Parts-2**

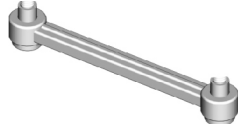
**HOPS-UP**

102058-Aluminum Front Bumper Upper Plate ★ 	102059-Aluminum Fuel Tank Cover ★ 	102060-Aluminum Front Gear Box Mount ★ 	102061-Aluminum Rear Gear Box Mount ★ 
102006-Aluminum lightweight flywheel ★ 	102063-Aluminum Combined Engine Mount/brace Complete ★ 	102065-Compact Aluminum Radio Tray ★ 	102064-Aluminum Battery case top cover ★ 
102025-Aluminum Centre Diff. Mount ★ 	102040-Aluminum Ackerman Plate ★ 		

The actual received parts may vary from the images!  
Optional parts are subject to change without prior notice.

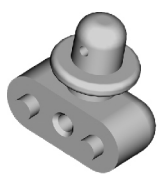







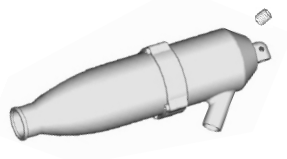

**Spare Parts-1**

06001-Chassis 	06002-Shock Absorber Buggy 2P 	06003-Front Bumper 	06004-Front Body Post 
06005-Wing Post 2P 	06006-Centre Front Dogbone 2P 	06007-Shock Pivot Ball 4P 	06008-Front Wheel Rim Buggy 2P 
06009-Front Tyre Buggy 2P 	06010-Front Wheel Complete Buggy 2P (06008+06009) 	06011-Front Lower Suspension Arm 2P 	06012-Rear Lower Suspension Arm 2P 
06013-Front Shock Tower 	06014-Rear Shock Tower 	06015-Radio Tray Mount 	06016-Steering Link/Front/rear Upper Link 2P 
06017-Wing Stay 2P 	06018-Front Lower Arm Round Pin B 2P 	06019-Rear Lower Arm Round Pin B 2P 	06020-Wing Lower Mount 2P 
06021-Buggy Wing 	06022-Front/rear Dogbone 2P 	06023-Shock Ball Mount 4P 	06024-Rear Wheel Rim Buggy 2P 



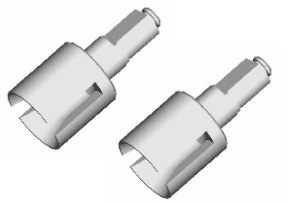
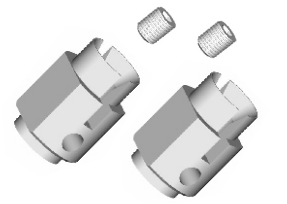
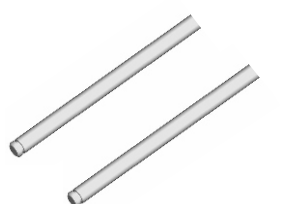
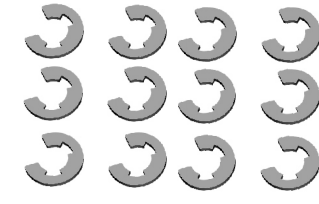
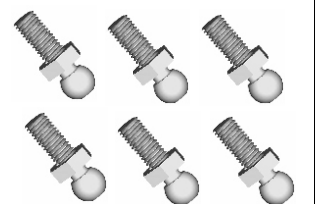
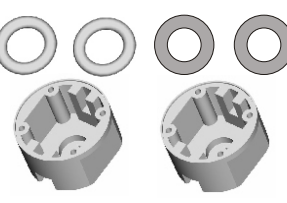

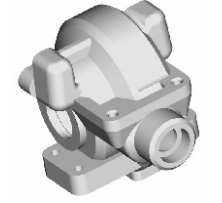
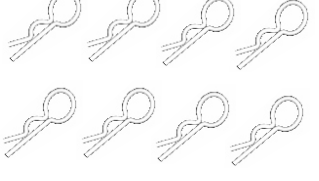
**Spare Parts-2**

06025-Rear Tyre Buggy 2P 	06026-Rear Wheel Complete Buggy 2P (06024+06025) 	06028-Seal Wheel Complete Buggy (Front) 2P (06009+06030) 	06029-Seal Wheel Complete Buggy (Rear) 2P (06009+06031) 
06030-Sealed Wheel Rim Buggy (Front) 2P 	06031-Sealed Wheel Rim Buggy (Rear) 2P 	06232-Spur Gear(47T) For Two Speed Transmission! 	06033-Spur Gear (42T) For Two Speed Transmission! 
06034-Two Speed Transmission Complete  <i>For Two Speed Transmission!</i>	02003-Centre Rear Dogbone 2P 	02004-Fuel Tank Complete 	02005-Rear Bumper 
02006-Centre Diff. Mount(front/rear) 	02011-Handle 	02013-Rear Upright (L/R)/Grub screws 2P 	02014-Steering Hub (L/R) 
02015-Front Hub Carrier (L/R) 2P 	02016-Universal Joint Cup B/Grub Screws 2P 	02017-Suspension Arm Brace 	02021-Rear Suspension Arm Bottom Mount 
02022-Front Suspension Arm Bottom Mount 	02023-Clutch Bell (Double Gears)  <b>Two Speed Required!</b>	02024-Diff. Gear Complete 	02025-Servo Saver Arm Complete A 

**Spare Parts-3**

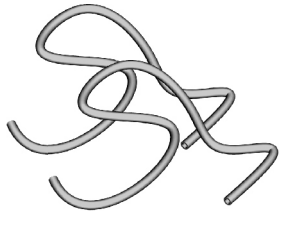

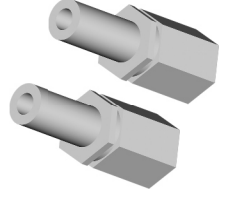
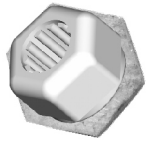
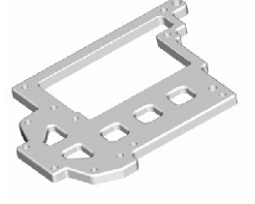
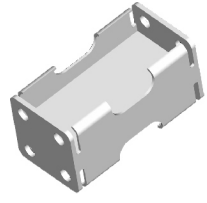

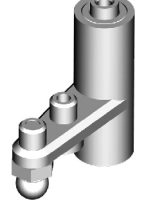
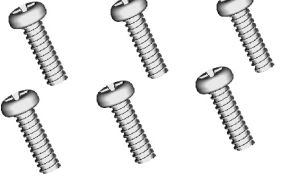
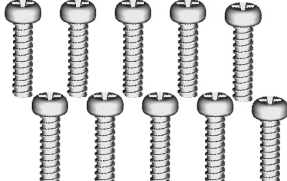
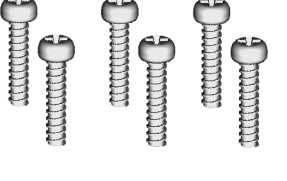



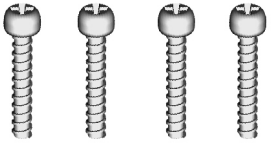
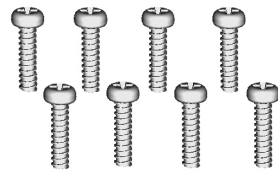
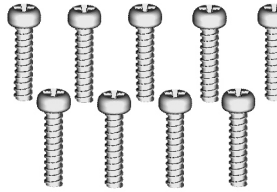
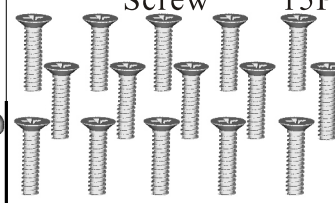
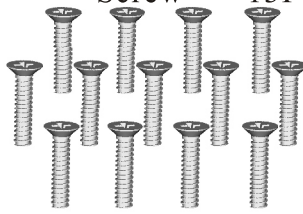

02026-Exhaust Pipe 	02027-Exhaust Silicon Rubber Pipe/Heat Rubber Tube 	02028-Air Filter w/ High Duty Flow Foam 	02029-Diff.Bevel Steel gear (Big) 
02030-Drive Pinion Complete 	02031-Exhaust Manifold 	02032-Universal Joint Cup C 2P 	02033-Wheel Axle 
02034-Universal Joint Cup A 2P 	02036-Front Lower Suspension Pin A 2P 	02037-E-clip 12P (Ø7. Ø4.Ø2.5.Ø2.3) 	02038-Ball Head Pivot Screw 6P 
02039-Diff.Box (w/two rings & steel washers) 	02043-Brake Cam 	02044-Brake Disc 2P 	02045-Two-Way Drive Clutch 
02046-Radio Tray Post A 4P 	02047-Radio Tray Post B 4P 	02048-Clutch Shoe Assembly (w/Spring) 02048(M) 02048(F) 	02049-Engine Holder w/Cap Head Screws 
02050-Battery /Receiver Box 	02051-Gear Box 	02053-Body Clip 8pcs 	02054-Two Speed Transmission Gear Post  <b>Two Speed Required!</b>

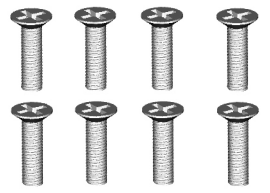
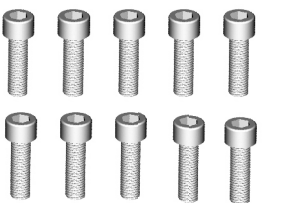
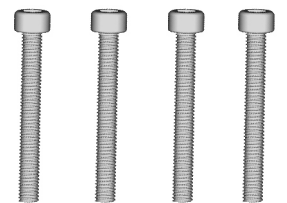
**Spare Parts-4**

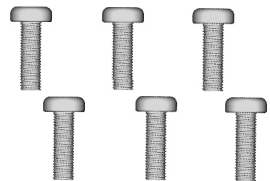
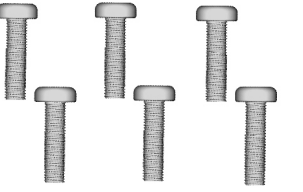

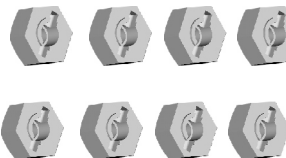
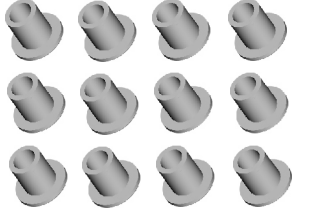

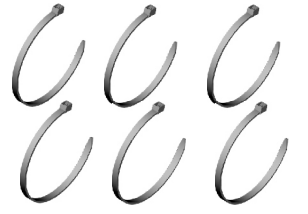
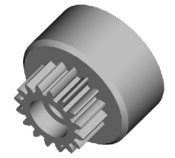
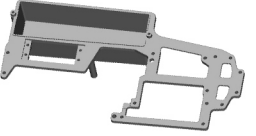
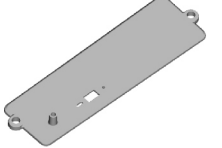

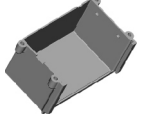

02055-Nylon Nut M4 8P 	02056-Throttle/Brake Assembly 	02057-Antenna Pipe 4P 	02058-Fuel Tube 2P 
02059-Exhaust Pipe Holder w/Cap Screw&Nut 	02060-Engine 01-12CXP(TAIWAN) 02-15CXP(TAIWAN) 03-16CXP(TAIWAN) 04-18CXP(TAIWAN) 05-16CXP(JAPAN) 06-18CXP(JAPAN) 	02063-Rear Lower Suspension Arm Round Pin A 2P 	02065-Flywheel Pilot Post 
02066-Diff.Pinions+ Bevel Gears+Pin 	02067-One-way Hex. Bearing w/ Hex. Nut 	02068-Engine Flywheel 	02069-Radio Tray 
02070-Battery Compartment 	02071-Receiver 	02072-Servo Arm 2P <i>Image may vary from actual unit.</i> 	02073-Servo Unit 
02074-Steering Set Bottom Joint 	02075-Servo Saver Arm Complete B 	02078-O-Ring 12P 	02079-Oil Bearing Ø15*Ø10*4 6P 
02080-Oil Bearing Ø5*Ø10*4 8P 	02081-BT3*8 BH Screw 6P 	02082-BT3*10 BH Screw 10P 	02083-BT3*12 BH Screw 6P 

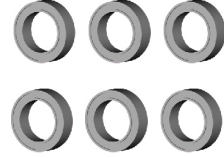

**Spare Parts-5**

02084-BT3*18 BH Screw 4P 	02085-BT2*8 BH Screw 8P 	02086-BT2*10 BH Screw 10P 	02087-TPE3*10 FH Screw 15P 
02088-TPE3*14FH Screw 13P 	02089-TPE3*15FH Screw 9P 	02090-TPE3*25FH Screw 4P 	02092-ISO 3*10 Screw 8P 
02093-M3*10 Cap Head Screw 10P 	02094-M3*28 Cap Head Screw 4P 	02095-M3*8 Cap Head Screw 4P 	02096-3*10 Cap Head Screw 6P 
02097- Cap Head Screw 3*14 6P 	02098-M3*4 Grub Hex. Screw 8P 	02099-M4*4 Grub Hex. Screw 10P 	02100-Wheel Hex. 8P 
02101-Steering Joint Bushing 12P 	02102-Nylon Nut M3 6P 	02103-Zip Tie 6P 	02107-Clutch Bell (single gear)  <b>Single Speed Required!</b>
02110-Radio /Fuel Tank Tray 	02111-Battery Cover 	02118-Receiver Side Plate 	02119-Receiver Compartment 

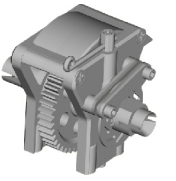
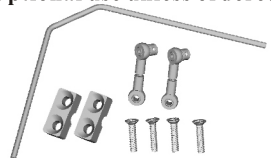
**Spare Parts-6**

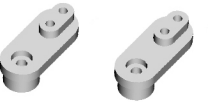
02121-Allen Screw 3*10 2P 	02127-Allen Screw 3*12 2P 	02123-Single Speed Transmission Gear Shaft  <b>Single Speed Required!</b>	02125-Battery Board 
02138-Ball Bearing $\phi 15*\phi 10*4$ 6P 	02139-Ball Bearing $\phi 10*\phi 5*4$ 8P 	05112-Spur Gear (44T) For Single Speed Transmission!  <b>Single Speed Required!</b>	05126-Single Speed Transmission Complete  <b>Single Speed Required!</b>
06070A-Front Anti Roll Bar Assembly Optional use unless ordered 	06070B-Rear Anti Roll Bar Assembly Optional use unless ordered 	03027-Charger/Battery Wire Connector Optional use unless ordered 	02372-Steering Servo Arm 2P 

**Optional Parts-1**









**HOPS-UP**

02115-Radio/Fuel Tank Tray  NEW NO.:102002	02128-Aluminum Engine Mount 2P  NEW NO.:102005	02124-Aluminum Exhaust Pipe  NEW NO.:102009	02132-Aluminum Front Hub Carrier (L/R)  NEW NO.:102010
02131-Aluminum Steering Hub(L/R)  NEW NO.:102011	02130-Aluminum Rear Hub Carrier (L/R)  NEW NO.:102012	02134-Aluminum Wheel Hex. Mount 4P  NEW NO.:102042	02191-Aluminum Nut M3 8P  NEW NO.:102048
02190-Aluminum Nut M4 4P  NEW NO.:102049	06038-Aluminum Shock Absorber 2P  NEW NO.:106004	06047-Universal Drive Joint 2P  NEW NO.:106015	06048-Aluminum Front/rear & Servo Link 2P  NEW NO.:106017
06050-Aluminum Front Lower Arm 2P  NEW NO.:106019	06049-Aluminum Rear Lower Arm 2P  NEW NO.:106021	06036-Aluminum Front Shock Tower  NEW NO.:106022	06037-Aluminum Rear Shock Tower  NEW NO.:106023
102025-Aluminum Centre Diff.Mount  NEW NO.:106019	02156-Aluminum Fuel Filter  NEW NO.:106021	02031A-Polished Aluminum manifold+ Pad  NEW NO.:106022	102059-Aluminum Fuel Tank Cover ★  NEW NO.:106023

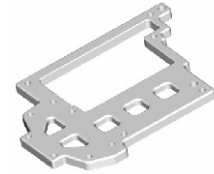
The images with ★ are still undeveloped and will come in near future.

**Optional Parts-2**

**HOPS-UP**

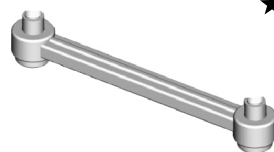
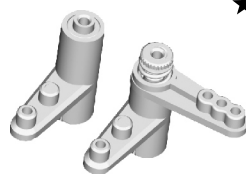
102006-Aluminum lightweight flywheel ★  NEW NO.:102006	102063-Aluminum Combined Engine Mount/brace Complete ★  NEW NO.:102063	102065-Compact Aluminum Radio Tray ★  NEW NO.:102065	106044-Aluminum Wing Stay ★  NEW NO.:106044
106045-Aluminum Wing Adjustable Mount ★  NEW NO.:106045	102060-Aluminum Front Gear Box Mount ★  NEW NO.:102060	102061-Aluminum Rear Gear Box Mount ★  NEW NO.:102061	102064-Aluminum Battery case top cover ★  NEW NO.:102064
102040-Aluminum Ackerman Plate ★  NEW NO.:102040	102057-Alum.Steering Servo Saver Complete ★  NEW NO.:102057		

The actual received parts may vary from the images!  
Optional parts are subject to change without prior notice.



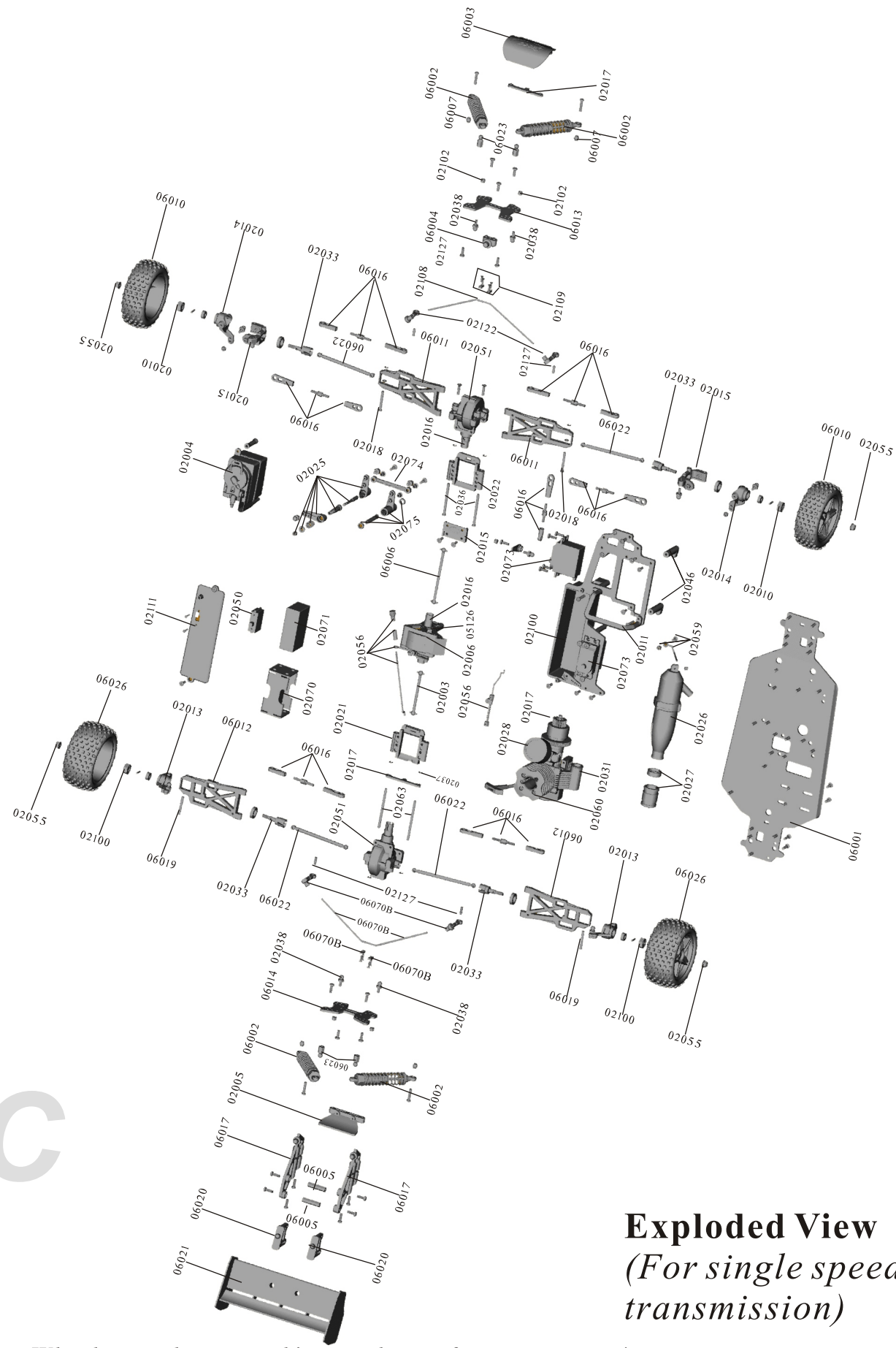

**Exploded View**  
*(For single speed transmission)*

*Note: Wheels complete are subject to change for your request!*

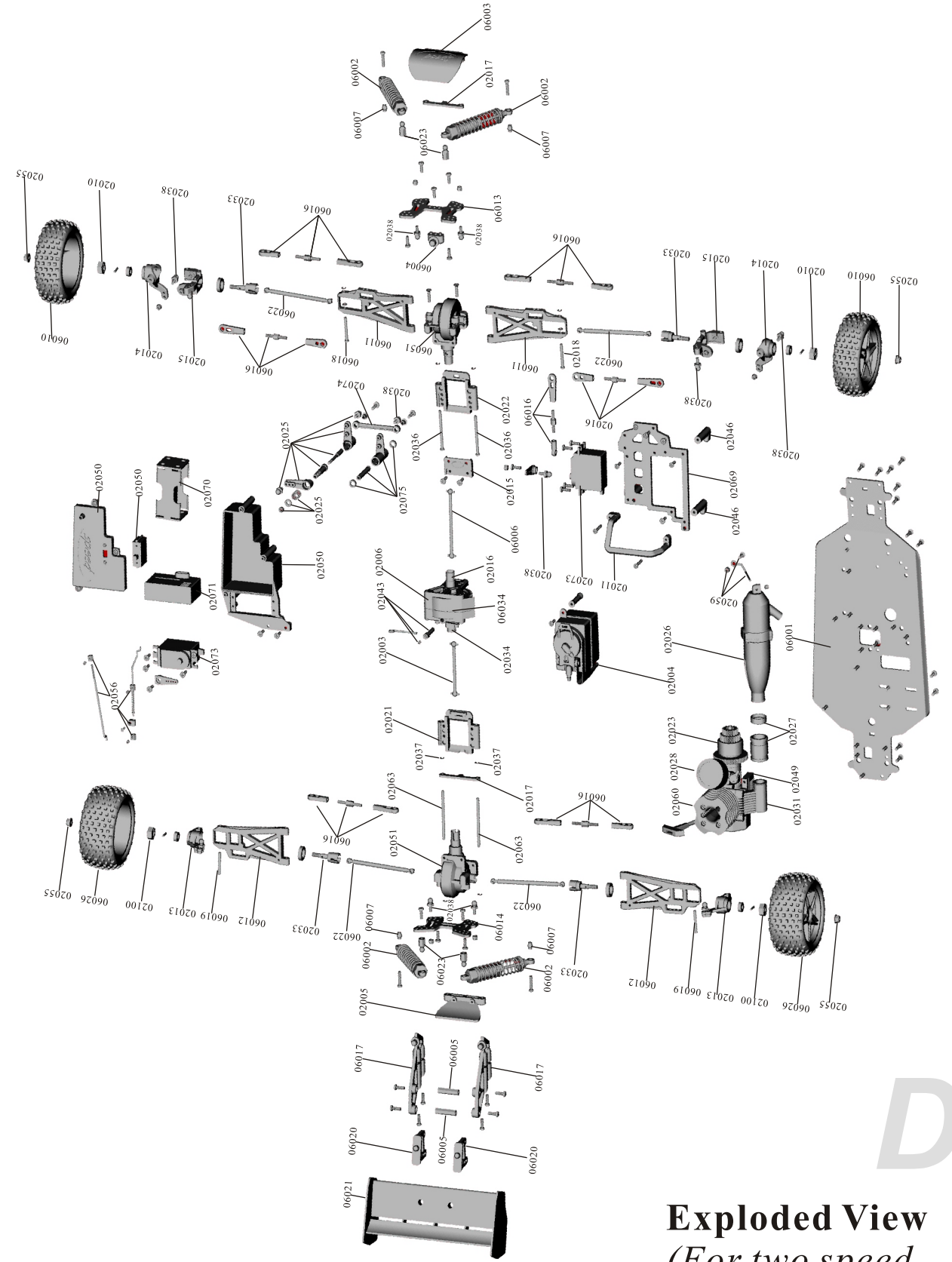

**Exploded View**  
*(For two speed transmission)*

*Note: Wheels complete are subject to change for your request!*