

# **INSTRUCTION MANUAL**

## **1/10th Scale 4WD Nitro Gas Power R/ C Monster Truck/Truggy and Off road ATV**

**A**  1/10th scale  
monster truck

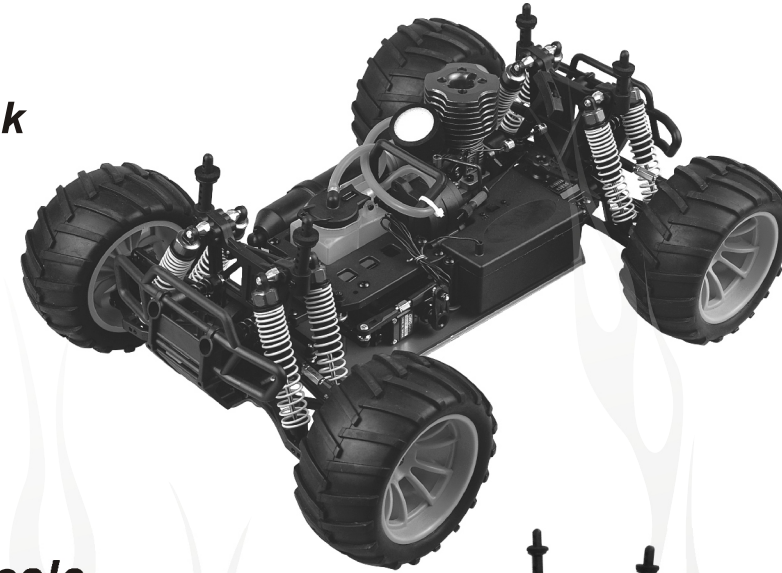

**B**  1/10th scale  
off road truggy



**C**  1/10th scale  
off road ATV



### **Notes:**

- ⇒ *Read and understand the instructions carefully before operating or assembling your racing model.*
- ⇒ *Specifications are subject to change without prior notice, and actual received model may vary from the images and/or descriptions in this manual.*

**NEW**

**A: 1/10th scale nitro gas power R/C monster truck**

**Specifications:**

Length	Width	Height	Wheelbase	Ground Clearance	Gear Ratio	Dia./Width Of Wheel	Engine Level
400mm	310mm	185mm	275mm	30mm	1:13.34	Φ120 *60mm	16-18 cpx required!

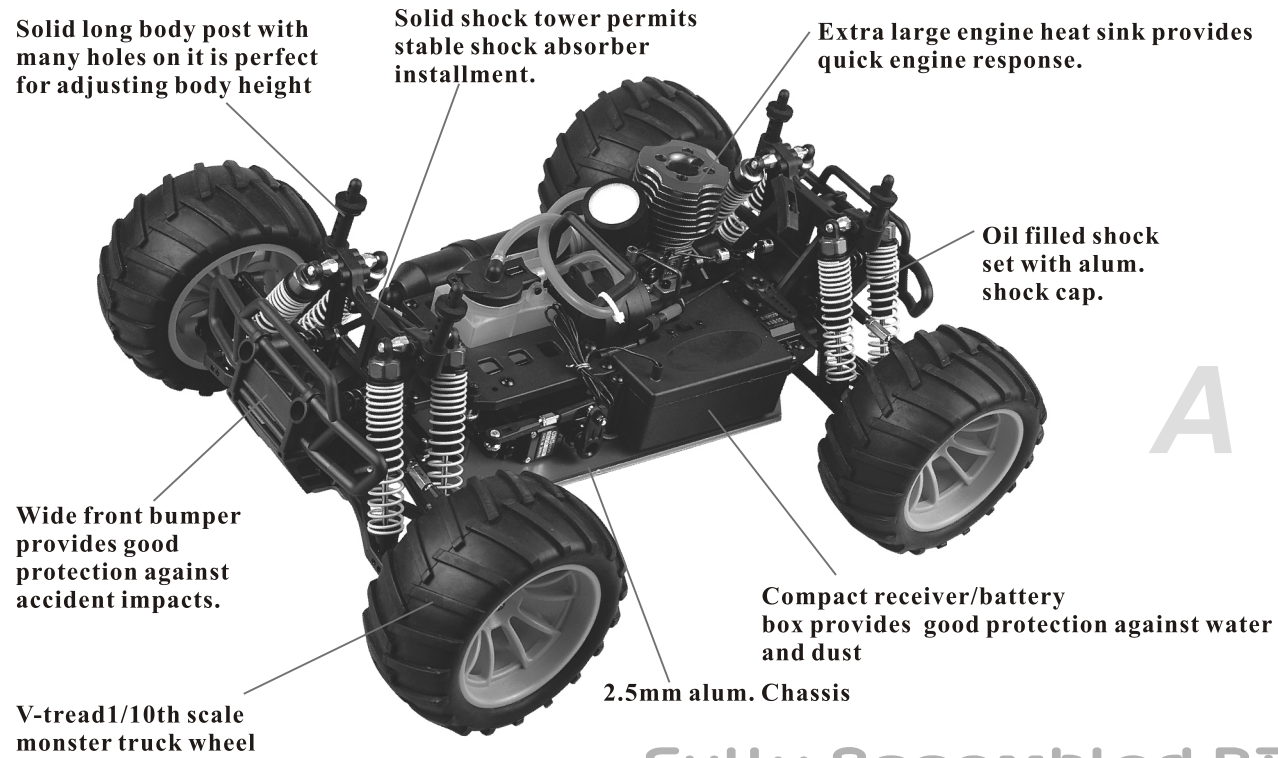

**Fully Assembled RTR**

**B: 1/10th scale nitro gas power off road truggy**

**Specifications:**

Length	Width	Height	Wheelbase	Ground Clearance	Gear Ratio	Dia./Width Of Wheel	Engine Level
400mm	300mm	160mm	275mm	35mm	1:5.84(H) 1:8.58(L)	Φ105 *60mm	16-18 cpx required!

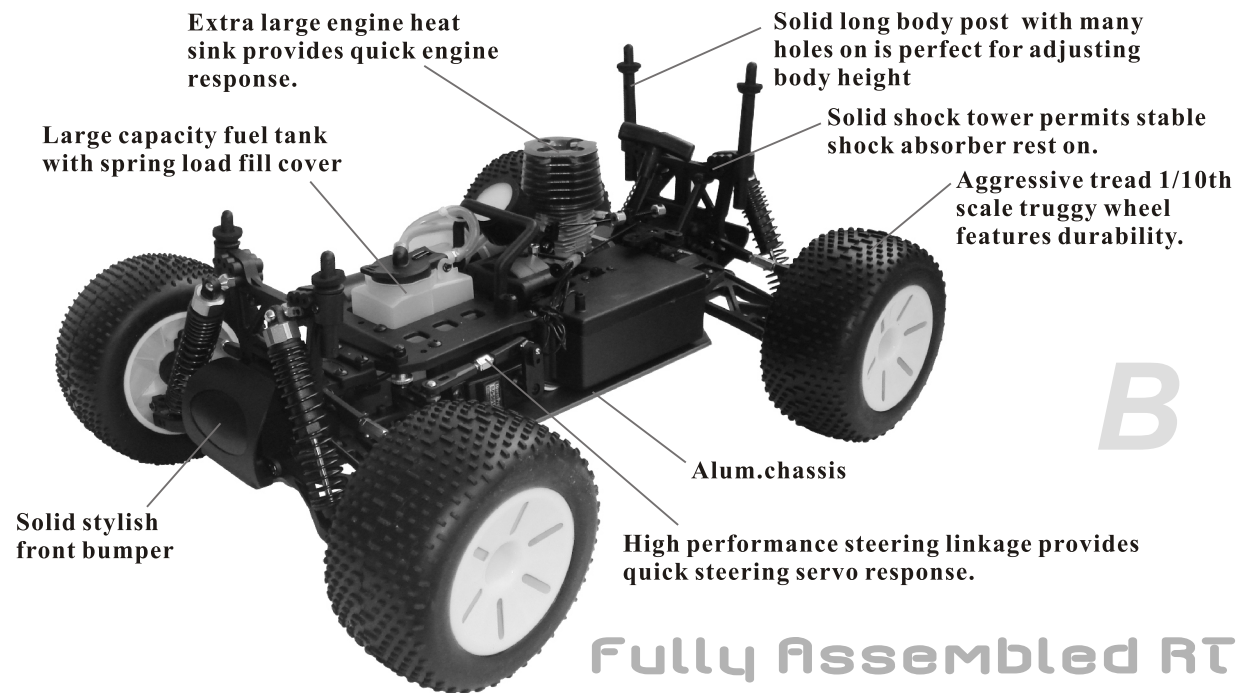

**Fully Assembled RTR**

**C: 1/10th scale nitro gas power R/C off road ATV**

**Specifications:**

Length	Width	Height	Wheelbase	Ground Clearance	Gear Ratio	Dia./Width Of Wheel	Engine Level
400mm	300mm	160mm Body Excluded	275mm	35mm	1:5.84(H) 1:8.58(L)	Φ105 *60mm	16-18 cpx required!

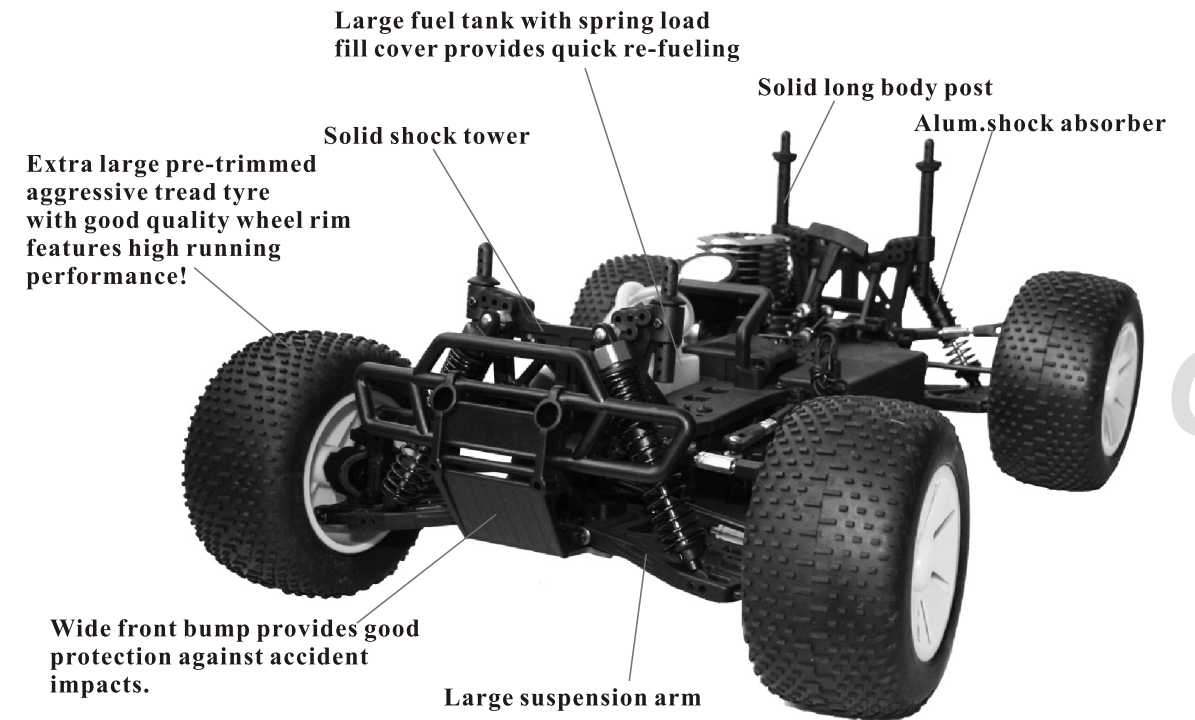

**Body Required:**

**Fully Assembled RTR**

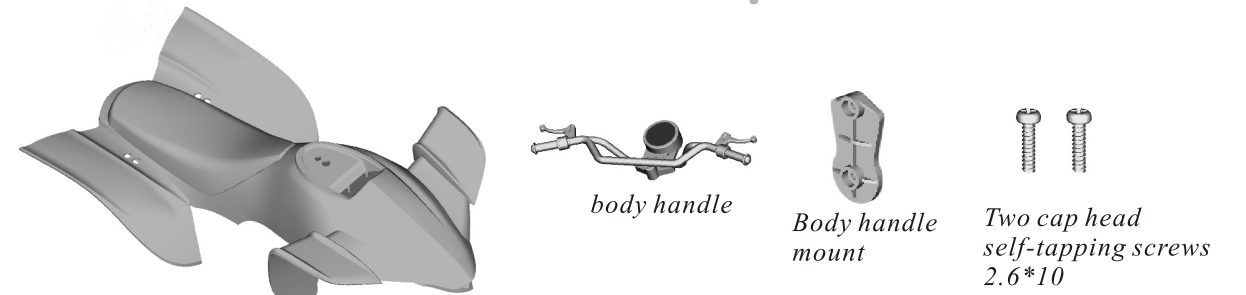

1/10th scale GP Monster ATV body

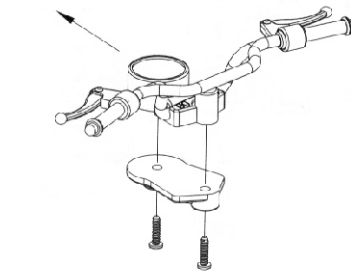

Install ATV rider with the rider post

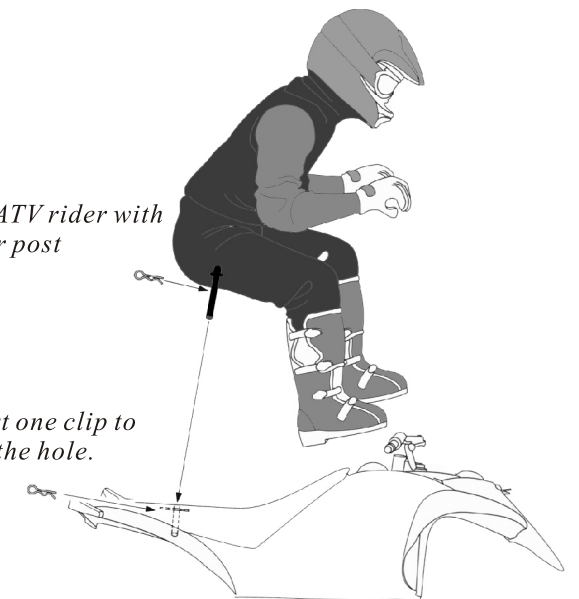

Insert one clip to lock the hole.

Use two cap head self-tapping screws (2.6\*10) and the handle mount to install the handle to the body.



## INTRODUCING YOUR VEHICLE...

**Congratulations on your purchase of this racing model. This model represents a new generation of 1/10th scale powerful off-road monster truck/Truggy and Monster ATV. This manual contains all the basic instructions for assembly, operation and maintenance. Please read and understand all instructions thoroughly before operating and building your model. We wish you good luck and enjoyment running your model.**

### Features Received:

- Large Capacity 75CC Leak Proof Fuel Tank With Overflow Pipe and Spring Loaded Fill Cover Providing Quick Re-fueling
- Front/rear Leakproof Differential With Metal Bevel Gears
- Lightweight Aluminium Flywheel 13.8g Provides Quick Engine Response
- Adjustable Oil Filled Shock Absorbers
- Differentials With 5 Screws Provide Quick Maintenance
- Powerful Disk Brake System With User Replaceable Pads
- Strong 2.5 mm Aluminum Chassis
- High Flow Dual Foam Element Air Filter (\*User Serviceable)
- 56 mm High Power Silencer And 7.5 mm Regulated Fuel Tank Vent

### Before assembling or operating your model...

Carefully read and understand all instructions before operating the vehicle.

Correct adjustment of high speed needle and idle adjustment are required before operating your vehicle. Refer to carburetor adjustments before operating vehicle.

The following items(not included unless specified) are required to operate your vehicle and are available from your model dealer or the local hobby shop.

#### Essential Items For Running Your Model

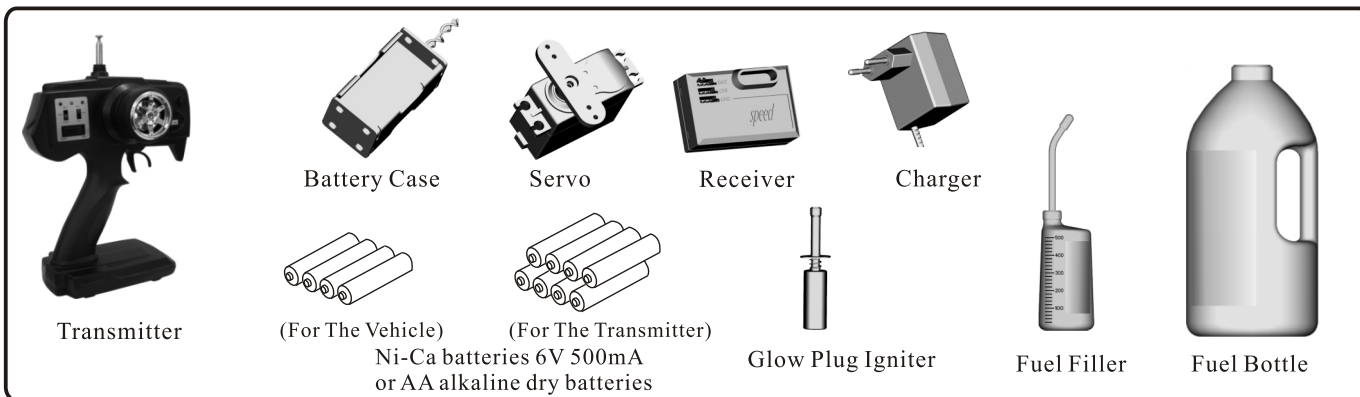

#### Tools For Assembling Your Model

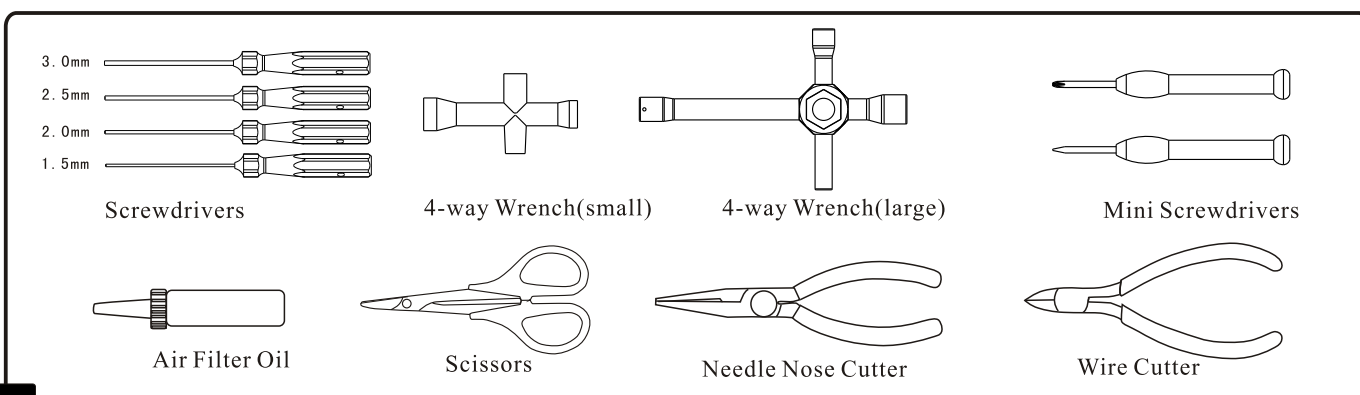

The following accessories available at our shop are for optional purchase to facilitate your operations!

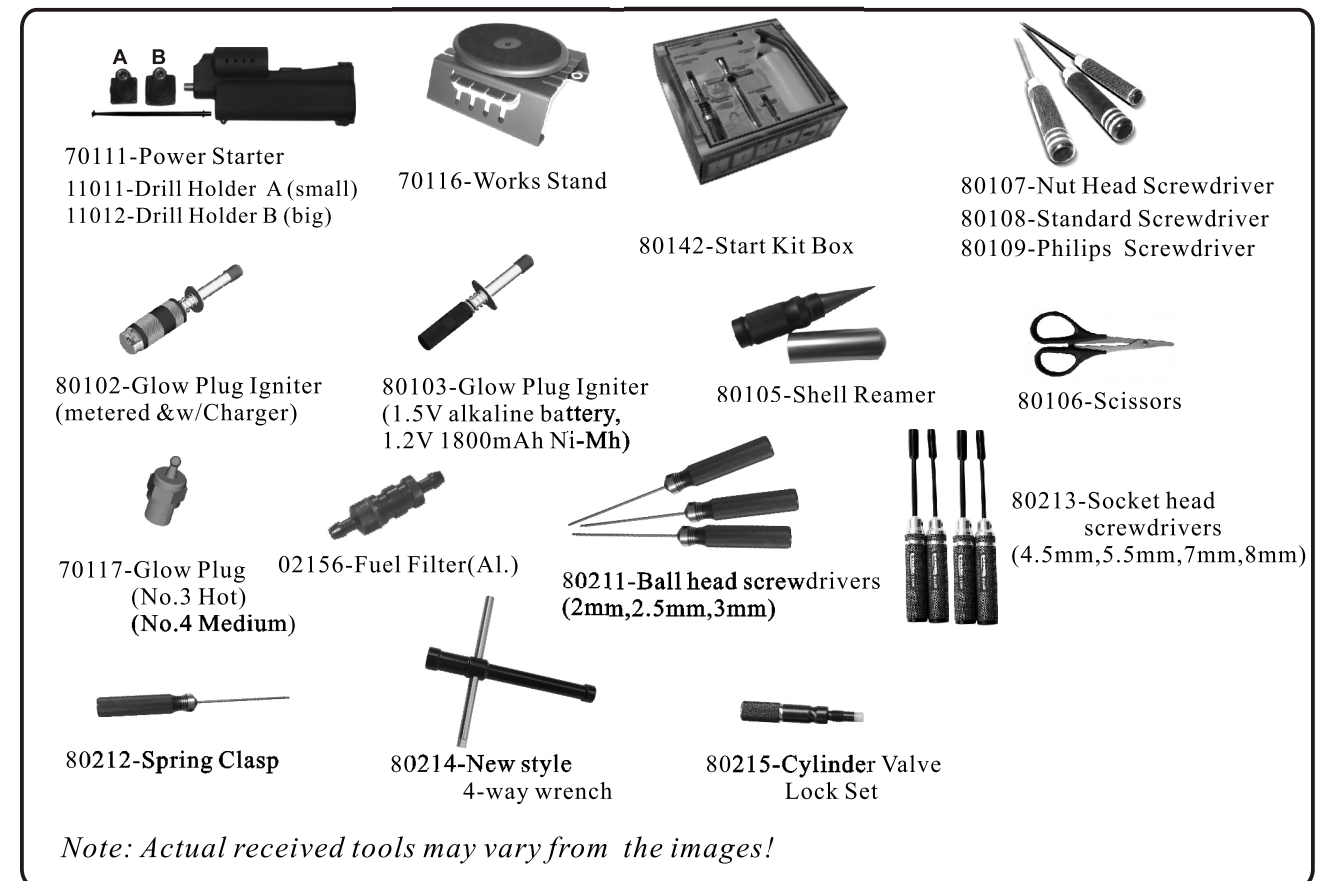

### Use of transmitter to control your vehicle...

#### Install the batteries in the transmitter

Insert the eight "AA" batteries into the battery compartment on the bottom of the transmitter.



#### Battery Precautions:

1. In order to keep better performance, we warmly recommend you to use the 1.5V alkaline batteries instead of the 1.2V chargeable batteries.
2. The batteries may leak in the event that they are installed with wrong polarities.
3. Do not use batteries of different types.
4. Do not mix old and new batteries.
5. Do not leave the batteries if not in use for long periods.

#### The function switches on the transmitter

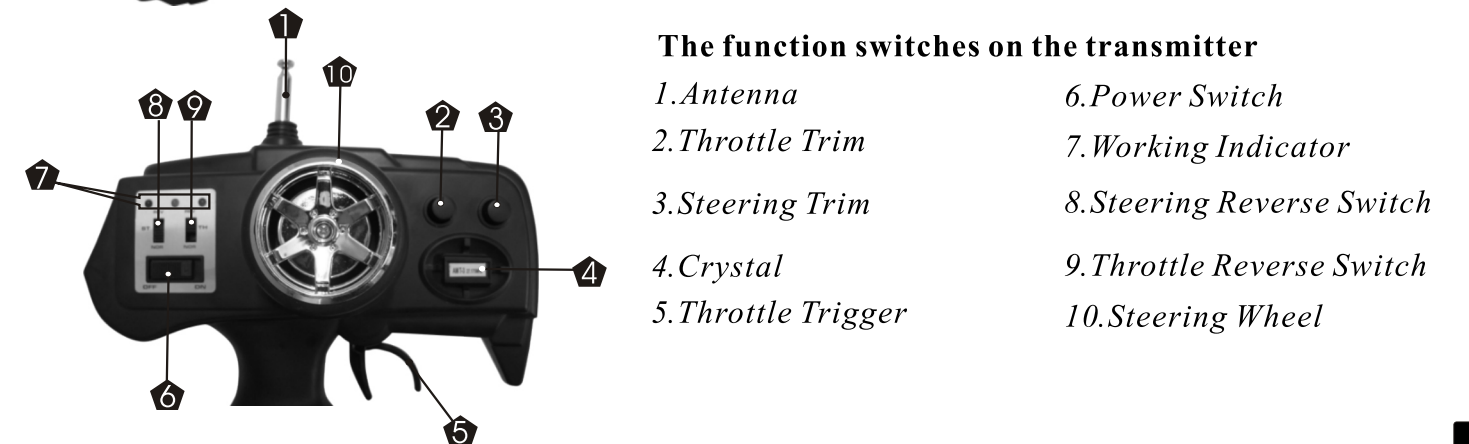

### Throttle Trigger

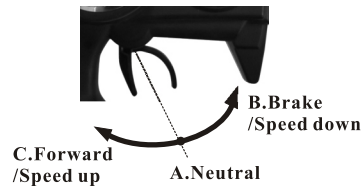

1. Push the trigger forwards to allow the vehicle to speed down to brake.
2. Pull the trigger backwards to allow the vehicle to go forward and speed up.

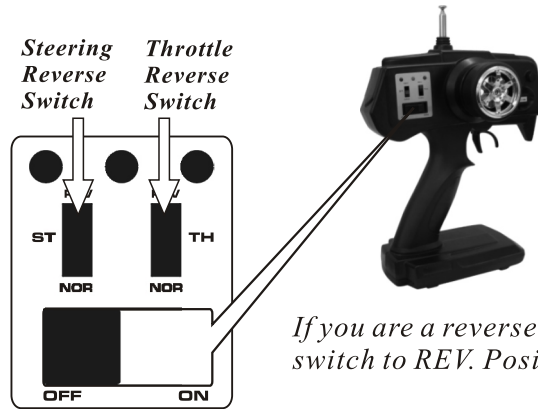

If you are a reverse operator, set the steering/throttle switch to REV. Position first.

### Steering Wheel

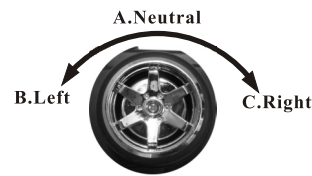

Turn the steering wheel to the left or right to let the vehicle turn left or right.

### Throttle/Steering Trim

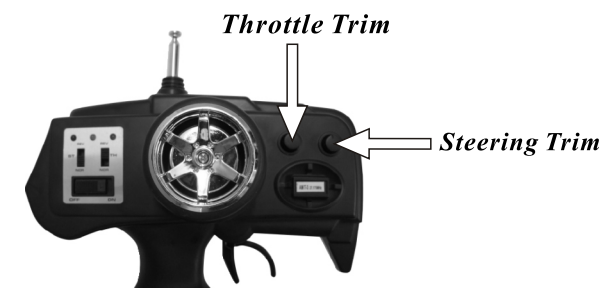
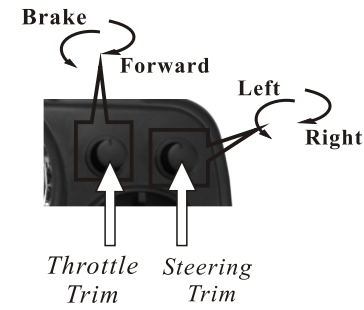

**Throttle Trim** is used to slightly trim the throttle servo when the trigger is at Neutral position.

**Steering Trim** is used to slightly trim the front wheels steering.

**Note:**  
If the front wheels are not straight when the trigger is set at Neutral position, you can adjust the steering trim to make them aligned.

## 2-Channel Radio System

Please read the following instructions before operating your vehicle. Servos must be centered before operating. Performance of vehicle will be affected if this procedure is not completed.

To perform initial servo adjustment, rotate both trim controls on transmitter to center position.

Power on the transmitter then power on the receiver (switch is located on top cover)

Servos are now centered, linkage adjustment can now be completed.

**Steering linkage:** With trim knob at center position front wheels should point in a straight ahead.

If wheels point in either direction remove control horn from servo and center the wheels (along drive-line axis) replace control horn and observe corrections and re-adjust if necessary.

Trim knob and servo are now centered, fine tuning of steering control can now be adjusted with steering trim knob on transmitter.

**Throttle/Brake linkage:** With trim knob at center position, throttle will be closed. If carburetor linkage is open at center position remove control horn from servo and center the linkage, replace control horn and observe corrections and re-adjust if necessary.

Trim knob and servo are now centered, fine tuning of throttle control can now be adjusted with steering trim knob on transmitter. Brake adjustment is performed via the thumb wheel on the end of the throttle linkage, brakes should not be applied at neutral position (vehicle must free-wheel when trigger is released) Before operating your new engine please perform required break in procedure otherwise performance and durability of engine shall be compromised.

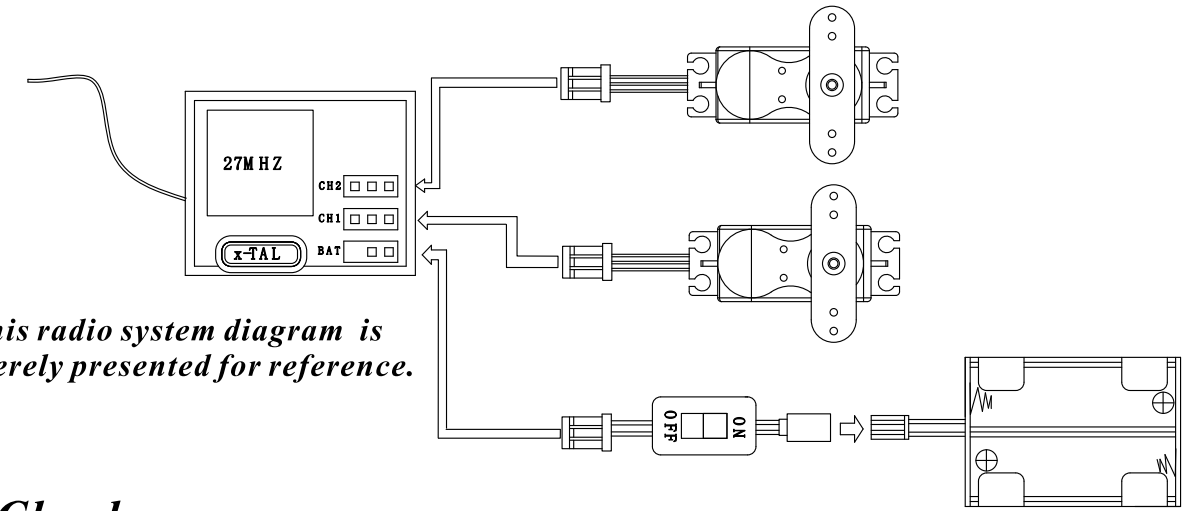

**Note:** This radio system diagram is merely presented for reference.

## Pre-Run Check

Please check your model before each driving.

### 1 Transmitter Switches

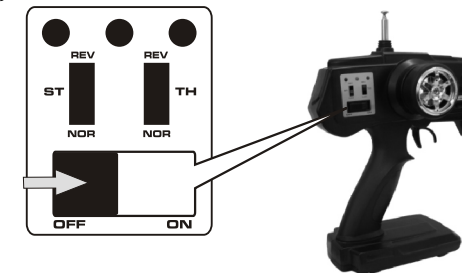

### Caution!

Make sure antenna is properly inserted and screwed in the transmitter. Antenna should be fully extended. Performance and control range of transmitter may be affected.

### 2 Chassis Switch

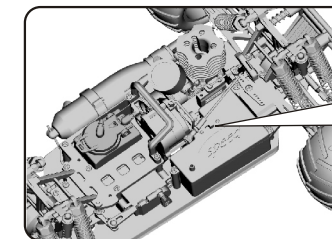

Turn on the chassis's switch.

### 3 Check Steering Performance

Operate the steering wheel to check if the front wheels move correctly.

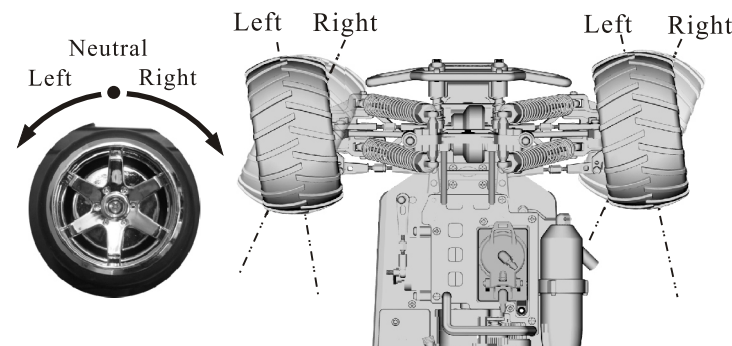

The front wheel movement is controlled by the steering wheel. For instance: When moving the steering wheel to the left, the vehicle front wheels will also turn left.

If the moving direction of the wheel is opposite to above mentioned, please change the Steering Reverse Switch position.



#### 4 Steering Trim Setting

Gently lift up the front wheels while adjusting the steering trim.

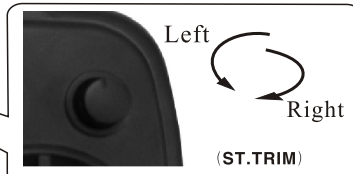
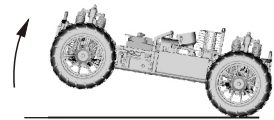

**Note:**  
Adjust the steering trim to center the front wheels of the vehicle when the steering wheel is at center position.

#### 5 Throttle Trim Setting

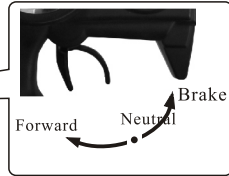

### Engine View

**Note:** The actual received engine may vary from this image. The image is presented for your reference only.

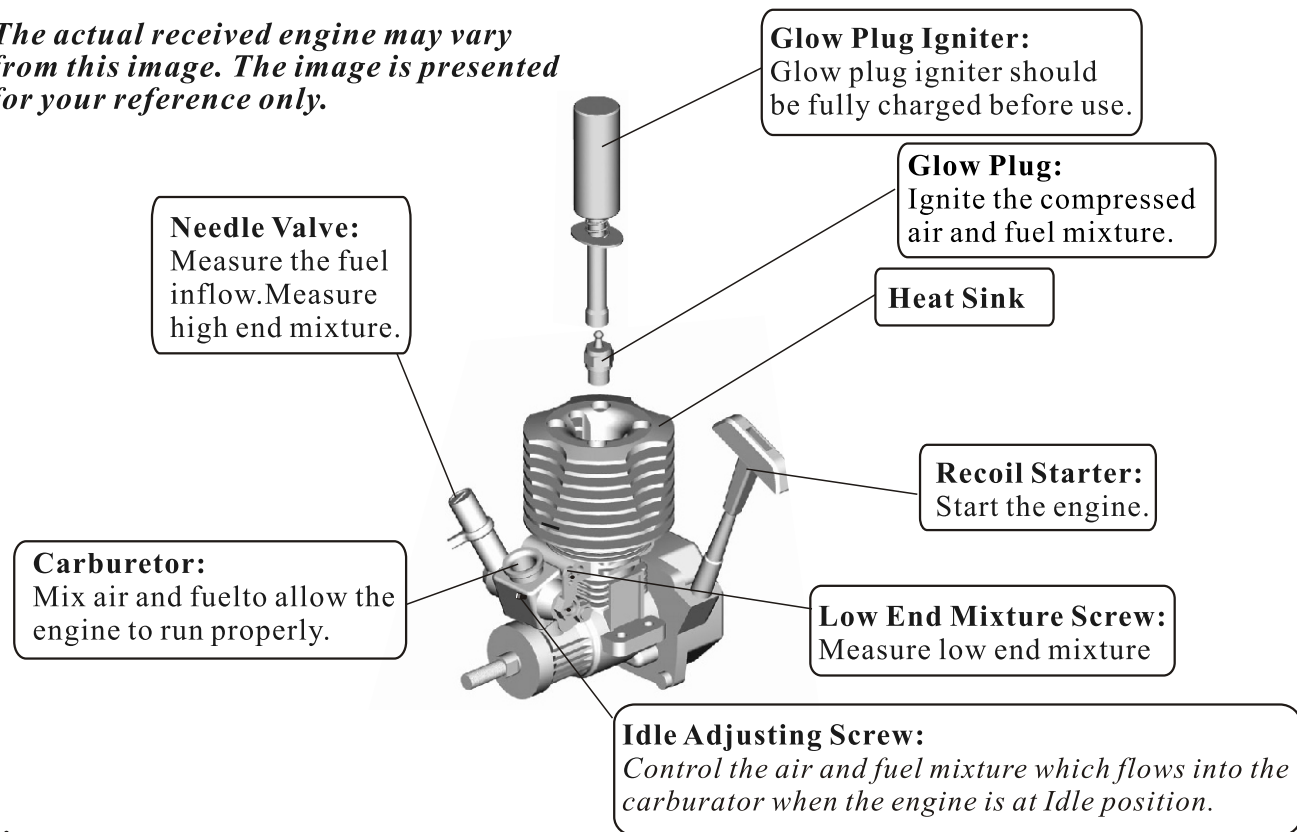

**Note:**  
The engine includes many high-precision parts. The original performance may be reduced due to wrong operations or assembly and disassembly.

### Engine Break In

Many hobby type glow engines require a break in period to provide final adjustment of internal parts after manufacturing. This procedure is required and must be completed by you/the user. To prevent excessive initial wear on internal engine parts a rich air/glow fuel mixture is required to perform your engine break in.

### Very important procedure must be followed !!

Break-in period 2 and 1/2 turns from full closed position (4-5 tanks of 10-15% nitro/20% oil content) must be used to perform break in, do not run engine full throttle for long periods during break-in. Once break-in has been performed lean out engine to best performance (2 turns to 1 and 1/2 turns from full closed position) you must always observe a trace amount of oil smoke from tune-pipe, if you do not see any smoke stop immediately and re-adjust needle valve till smoke is observed. Always perform needle valve adjustment first, and then perform idle adjustment on a warmed-up engine. Environment conditions may require further adjustments. Clean-out engine and exhaust system by applying high throttle (3/4 throttle) for 2 seconds after adjustment to permit effectiveness of adjustment to be observed. We highly recommend replacing the engine " Glow Plug " (part # 70117) after you have completed the break-in. It is of normal occurrence during the break-in that miniscule particles of metal adhere to the glow element. The particles of metal isolate the glow element and affect overall engine performance. You may also be required to replace your glow plug during your break in procedure. Normal nitro content: Once break-in has been performed 20% - 35% Lubrication: We highly recommend a Premium glow fuel with a Synthetic/Castor blend of a minimum of 16% and maximum of 20% combined lubricant content.

### Engine Adjustment/Maintenance

#### Engine Adjustment

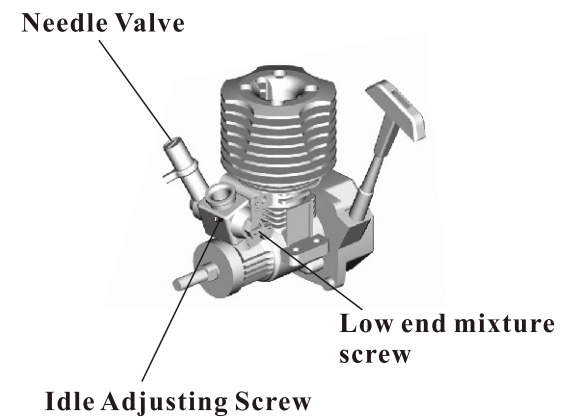

##### 1. Needle Valve Adjustment

- A. Start the engine to run your car
- B. Keep an eye on the current running speed when the car is running straight with the throttle control set to High. The speed will go up when you screw in the needle valve at an angle of 10 or 20 degrees.
- C. When continuing to screw the needle valve further in, the engine will become overheated and subject to damage. If it is the case, immediately unscrew the needle valve at an angle of 10 or 20 degrees to allow the engine to return to normal running.

##### Acceleration from idle position.

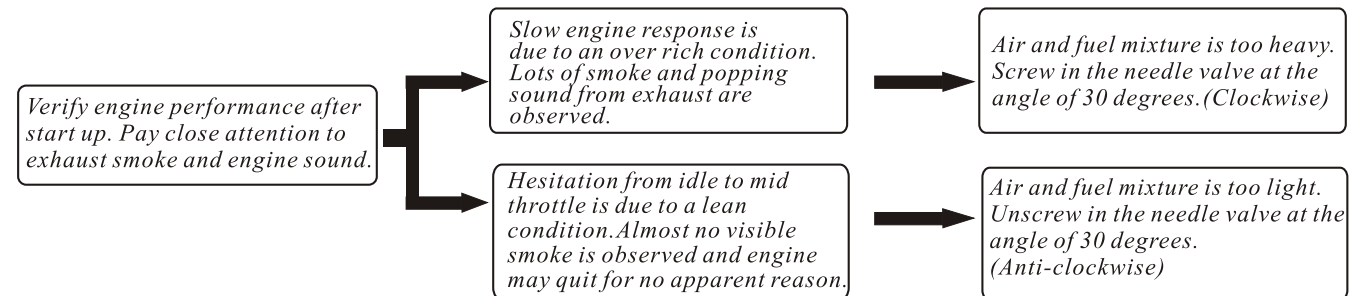

##### 2. Low end Adjusting Screw

Low end adjusting screw is used to trim the air and fuel mixture to flow into the carburetor.

##### 3. Idle Adjusting Screw

Idle adjusting screw is used to control the air and fuel mixture which flows into the carburetor when the engine is at Idle position.

## Engine Maintenance

1. Empty fuel tank and fuel lines before storing your vehicle.
2. Use premium "After Run Oil" this lubricant is utilised for storing of your engine  
Observe manufacturers instructions.
3. Remove all dirt and debris from vehicle with small brush (tooth brush) and/or with compressed air (observe proper personal security when operating air equipment)
4. Inspect and adjust all moving parts for excessive play, if adjustment cannot remove all excessive play observe part integrity and replace if required.
5. Correct lubrication of all bearings and moving mechanism is necessary for proper operation.
6. Disconnect and inspect batteries for leakage, recharge as required, do not store vehicle with batteries in unit for prolonged periods.
7. Operating radio controlled devices in wet/damp conditions is not suggested, vehicle may lose traction abruptly, and vehicle may be subject to water penetration in receiver compartment or in servos and loss of control of vehicle is imminent.

## To start the engine

- 1 Fill the fuel tank with fuel

Note: Actual received vehicle may vary from the images!

Note: Be extremely diligent in preventing fuel spill.

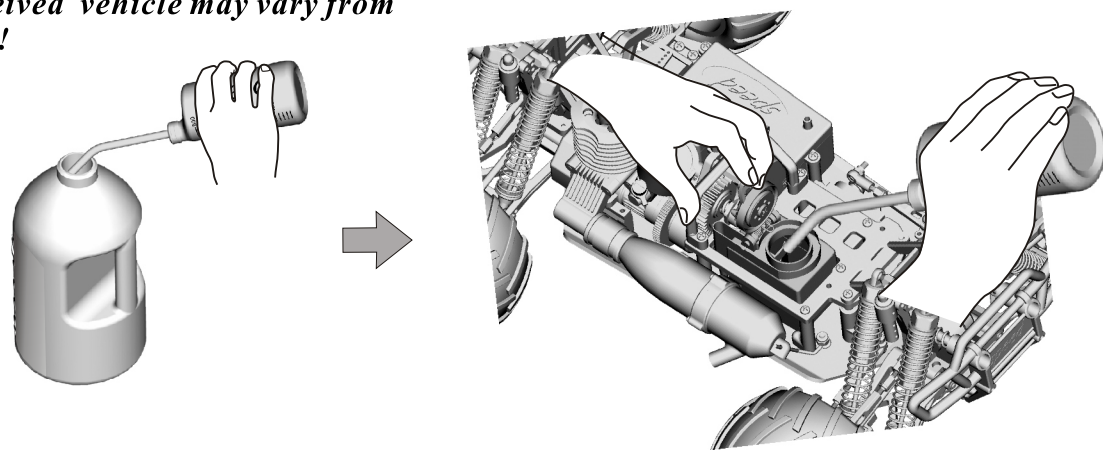

- 2 Switch on the transmitter, then the receiver.

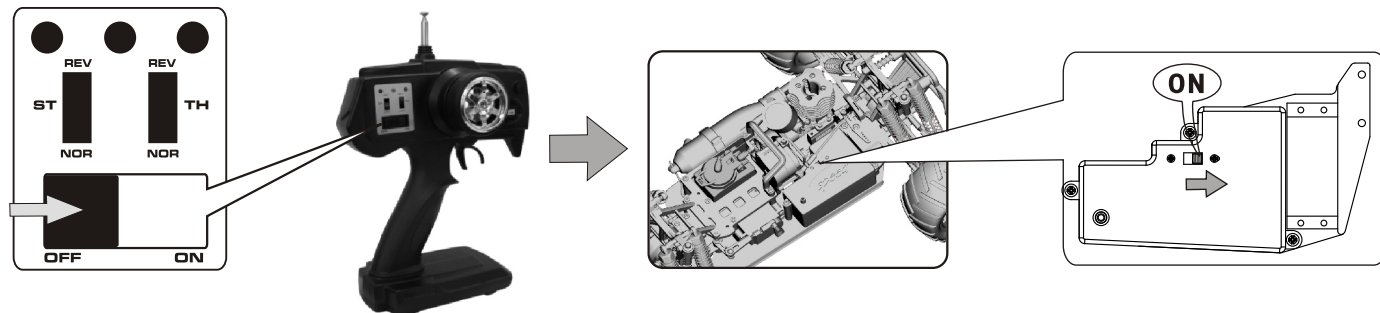

- 3 Remove the air filter.

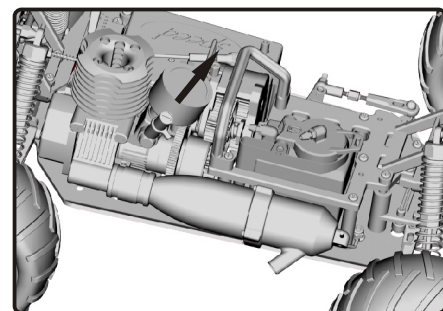

- 4 Open the throttle fully, and flow 2~3 drops fuel into the carburetor.

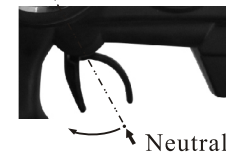

Pull the trigger back to reach the Full speed

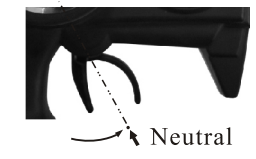
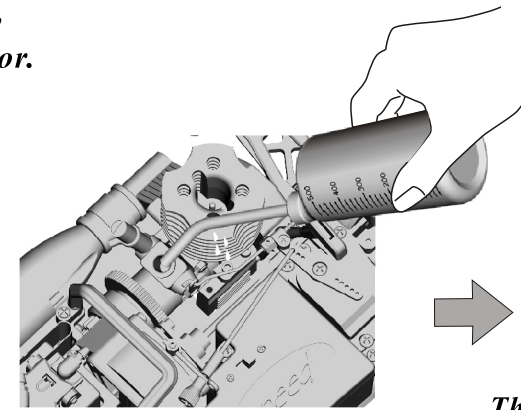

The throttle level returns to Neutral

- 5 Attach the air filter

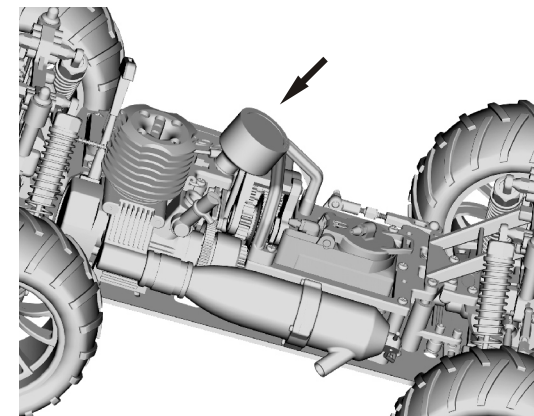

- 6 Use the glow plug igniter to excite the engine. If the glow plug igniter is short of power, please charge it before use.

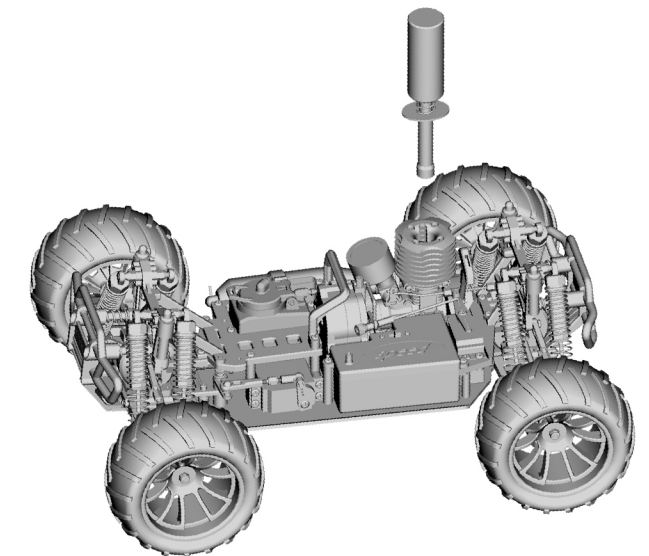

- 7 Hold the car securely while pulling the recoil starter cord.

### ⚠ Caution!

► To avoid engine damage, never force hard to crank engine, remove glow plug and ventilate engine by pulling the pull cord a few times. Install glow plug and try starting.

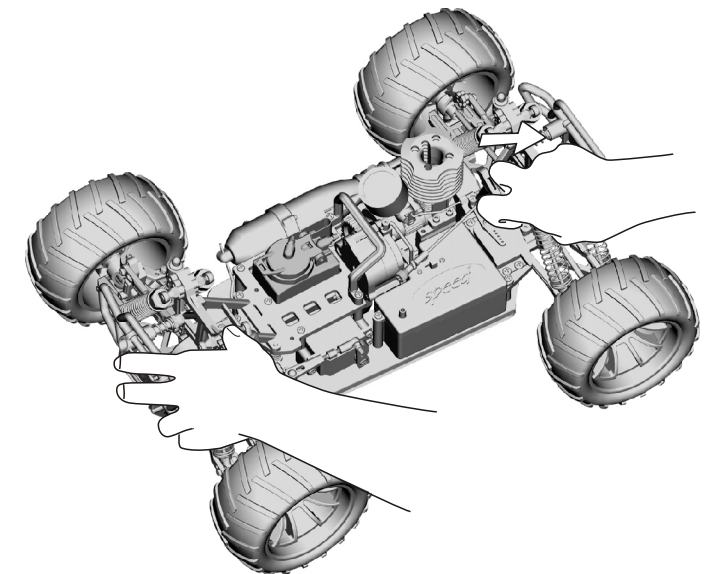



## Stop Running The Engine

1. Pinch fuel line with a peg to stop fuel from flowing into the engine.

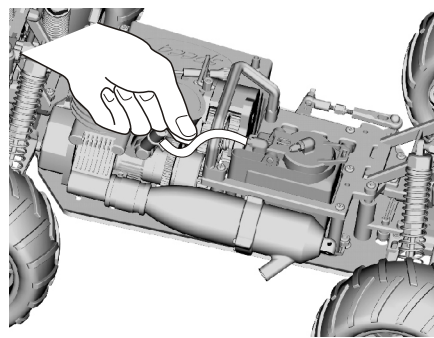

2. Turn off the receiver then the transmitter.

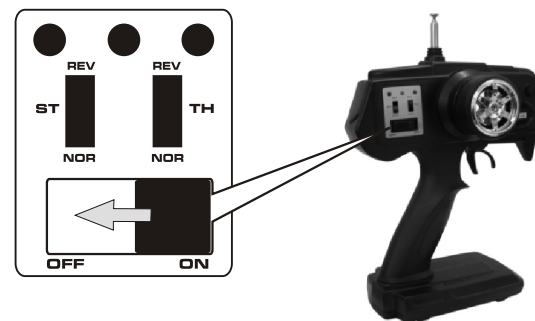
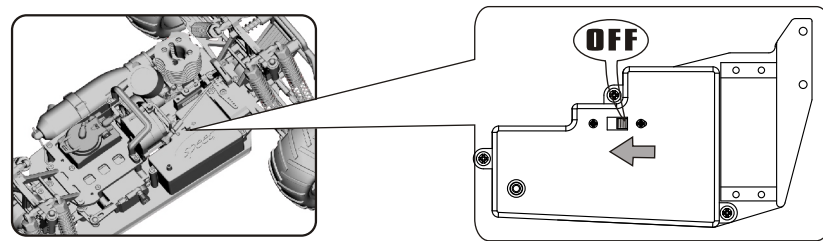

### WARNING

The engine, exhaust manifold and the tune-pipe are hot after running your vehicle and can burn your body. Do not touch any of these components immediately after running. Permit them to cool down first.

## ENGINE START TROUBLESHOOTING

If the engine fails to be started after the normal procedures are performed, please take it seriously and get down to the following:

- Verify that the approx. 0.5cc of fuel has flowed into the engine. The fuel that flowed into the engine should not be too heavy. Otherwise, the engine will become flooded and unable to function.
- Verify that a full-charged glow plug igniter is used. (If the glow plug can be excited and its pin subjects to turn red, it indicates that the glow plug igniter is of enough power. Please immediately charge it if necessary)

If the primed engine is still unable to be started by a full-charged glow plug igniter, you should perform the following procedures.

(The needle valve and/or the low end mixture screw had been properly calibrated at factory. However, you can perform some calibrations on them if necessary.)

1. Use the screwdriver to turn the needle valve and low end mixture screw tightly (clockwise), then unscrew them approx. 3 turns (anti-clockwise) to perform the correct calibration.

Note: Some hobby type glow engines have no the low end mixture screw. If it is the case, you are only required to unscrew the needle valve.

2. Ensure there is no wrong with fuel line and fuel route.

3. Before starting the engine, verify the glow plug igniter is of enough power and the good glow plug is used.

4. Use your fingers or a dry cloth to stifle the exhaust vent while pulling the recoil starter cord 5-6 times.

These actions will allow the fuel to flow into the engine.

(Note: Do not allow your fingers and body to touch the overheated engine and exhaust vent after the engine is started. Failure to do so will cause severe burns to your body)

5. Use the glow plug igniter to excite the engine while pulling the recoil starter cord several times until the engine start is observed.

## Troubleshooting no-start condition and engine performance.

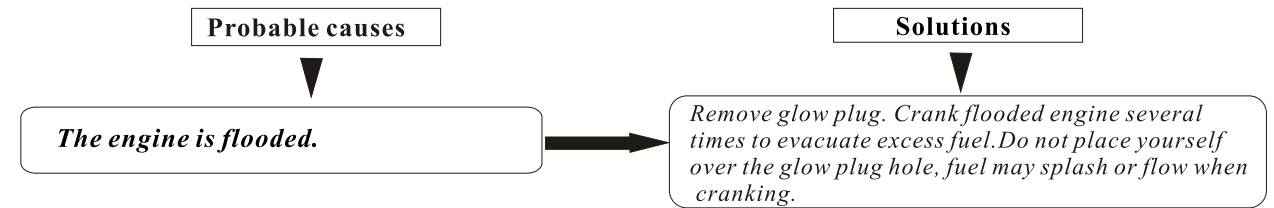

## Engine can be cranked but will not start.

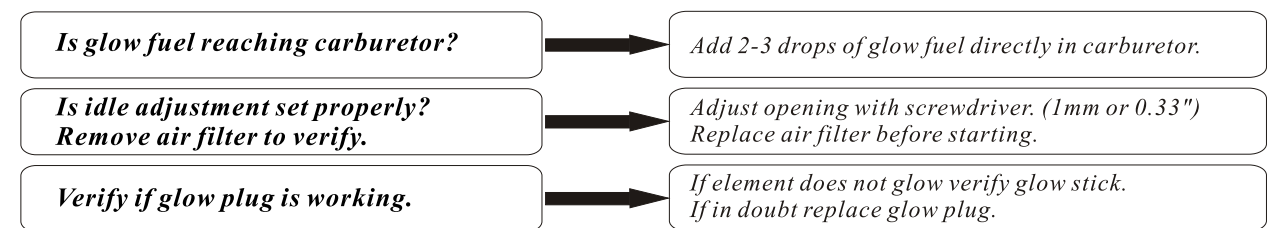

## Miscellaneous

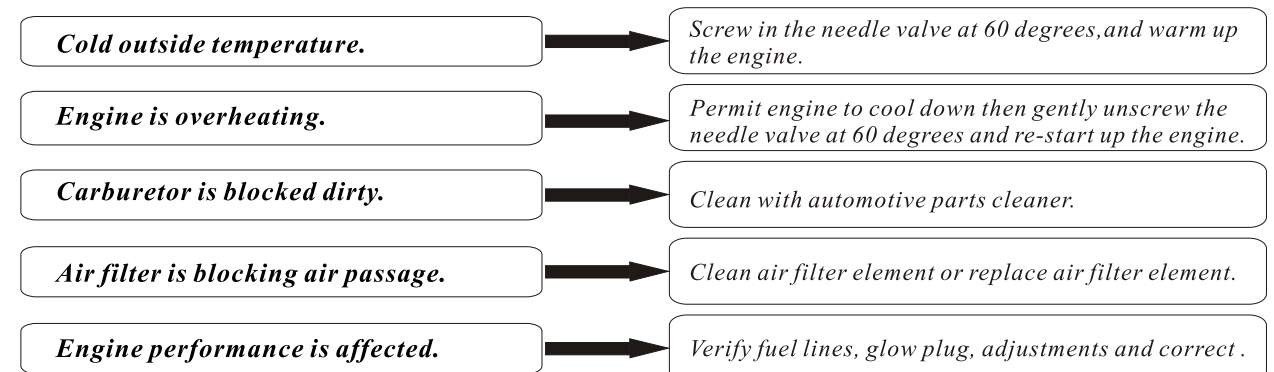

## Troubleshooting List

ISSUES	REASONS	SOLUTIONS
THE ENGINE FAILS TO START.	1. The fuel tank is empty or the carburetor is not primed properly. 2. The glow plug is bad or the batteries are dead. 3. The fuel lines, the air filter, or the muffler is clogged. 4. The engine is flooded. 5. The carburetor is not adjusted properly. 6. The servo linkage is not adjusted properly.	1. Fill the fuel tank up or prime the throttle. 2. Replace the glow plug or charge the batteries. 3. Clean or replace the clogged part(s). 4. Remove the glow plug and discharge fuel. 5. Set the Needle Valve/Low End Mixture Screw and the Idle Adjusting Screw to the Original position. 6. Set the servo to Neutral then re-adjust it.
THE ENGINE CAN START BUT STALL IMMEDIATELY.	1. The fuel tank is empty. 2. The fuel lines, the air filter, or the muffler is clogged. 3. The carburetor is not adjusted properly. 4. The engine is flooded.	1. Fill up the fuel tank. 2. Clean or replace the clogged part(s). 3. Re-adjust Idle Adjusting Screw and Needle Valve/Low End Mixture Screw. 4. Allow the engine to thoroughly cool down and turn the Needle Valve open at the angle of 30 degrees.
POOR REACTION RESPONSE ON THE ENGINE.	1. The carburetor is not adjusted properly. 2. Low fuel pressure level was found on the muffler.	1. Re-adjust Needle Valve/Low End Mixture Screw. 2. Install the pressure line from the muffler to the fuel tank correctly.
THE VEHICLE BECOMES DIFFICULT TO CONTROL.	1. The batteries on the transmitter/receiver are weak. 2. Radio antenna performs bad receptions. 3. The servo linkage is not adjusted properly.	1. Replace or charge the batteries. 2. Extend the transmitter antenna fully to obtain better receptions. 3. Set the servo to Neutral then re-adjust it.

**18CXP ENGINE ASSEMBLY DIAGRAM**

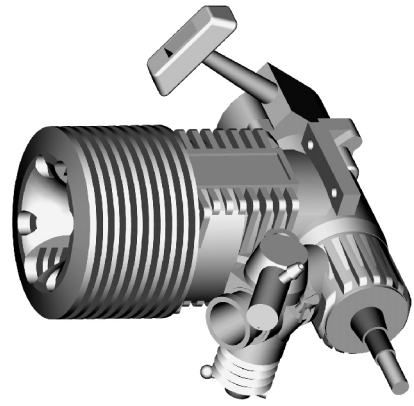

- R001-Glow Plug
- R002-Screw 4P
- R003-Cylinder Head
- R004-Gasket
- R005-Cylinder Piston
- R006-Piston Pin
- R007-Joint Lever
- R008-Carburetor Assembly
- R009-Nut
- R010-Small Flywheel
- R011-Roller Bearing(Front)
- R012-Engine Main Body
- R013-Carburetor Post
- R014-Roller Bearing(Rear)
- R015-Crankshaft
- R016-Clutch Rolling Set
- R017-Gasket for Rear Housing
- R018-Rear Housing
- R019-Screw 4P
- R020-Pull Start Lever
- R021-Screw 4P

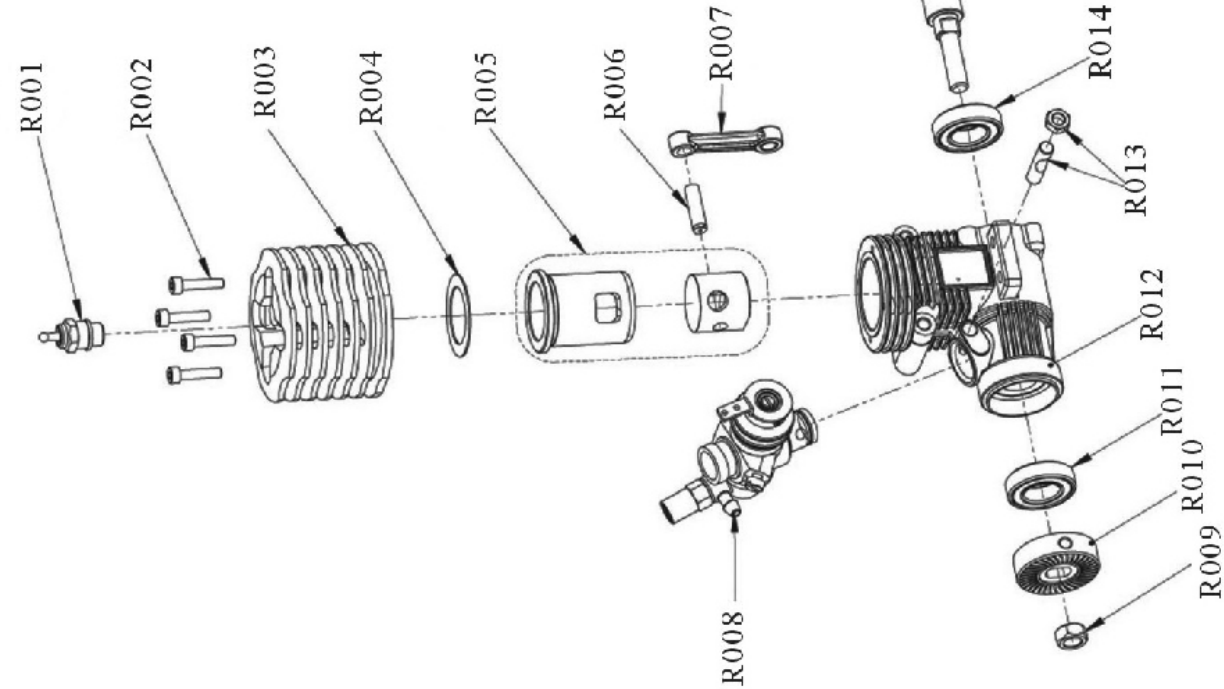

**1/10th Scale Monster Truck Shock Assembly**

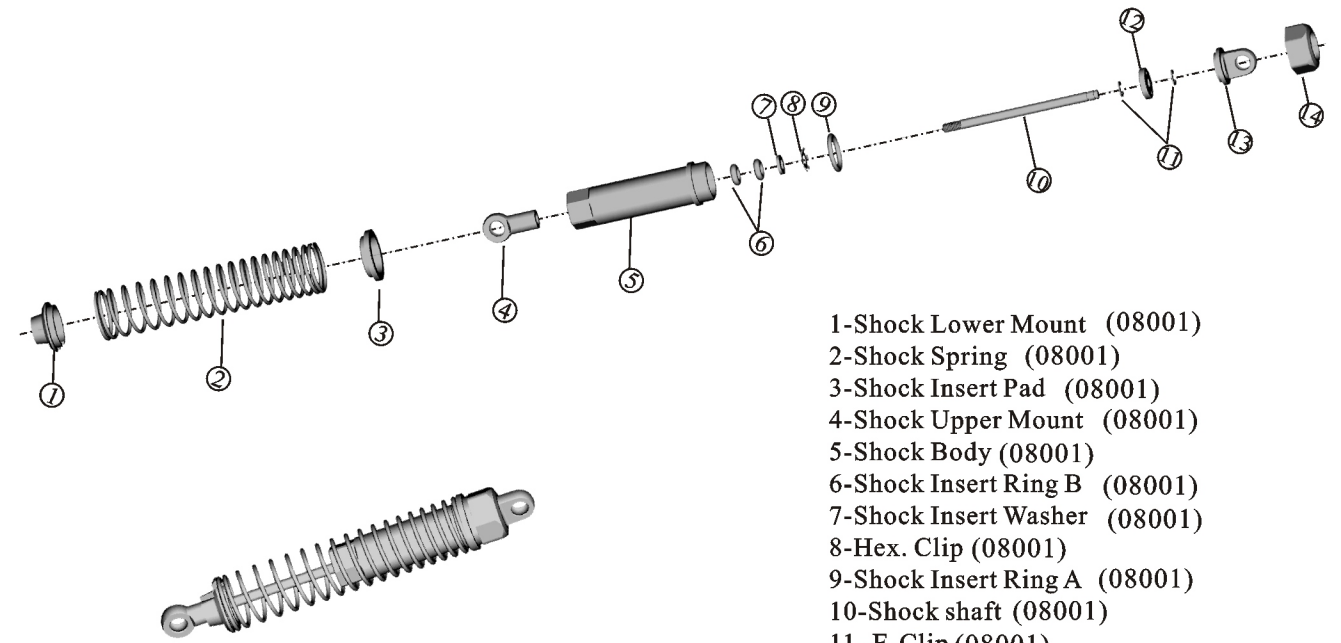

- 1-Shock Lower Mount (08001)
- 2-Shock Spring (08001)
- 3-Shock Insert Pad (08001)
- 4-Shock Upper Mount (08001)
- 5-Shock Body (08001)
- 6-Shock Insert Ring B (08001)
- 7-Shock Insert Washer (08001)
- 8-Hex. Clip (08001)
- 9-Shock Insert Ring A (08001)
- 10-Shock shaft (08001)
- 11- E-Clip (08001)
- 12-Shock Piston (08001)
- 13-Shock Ball (08001)
- 14-Shock Upper Cap (08001)

**1/10th Scale Truggy / Off road ATV Shock Assembly**

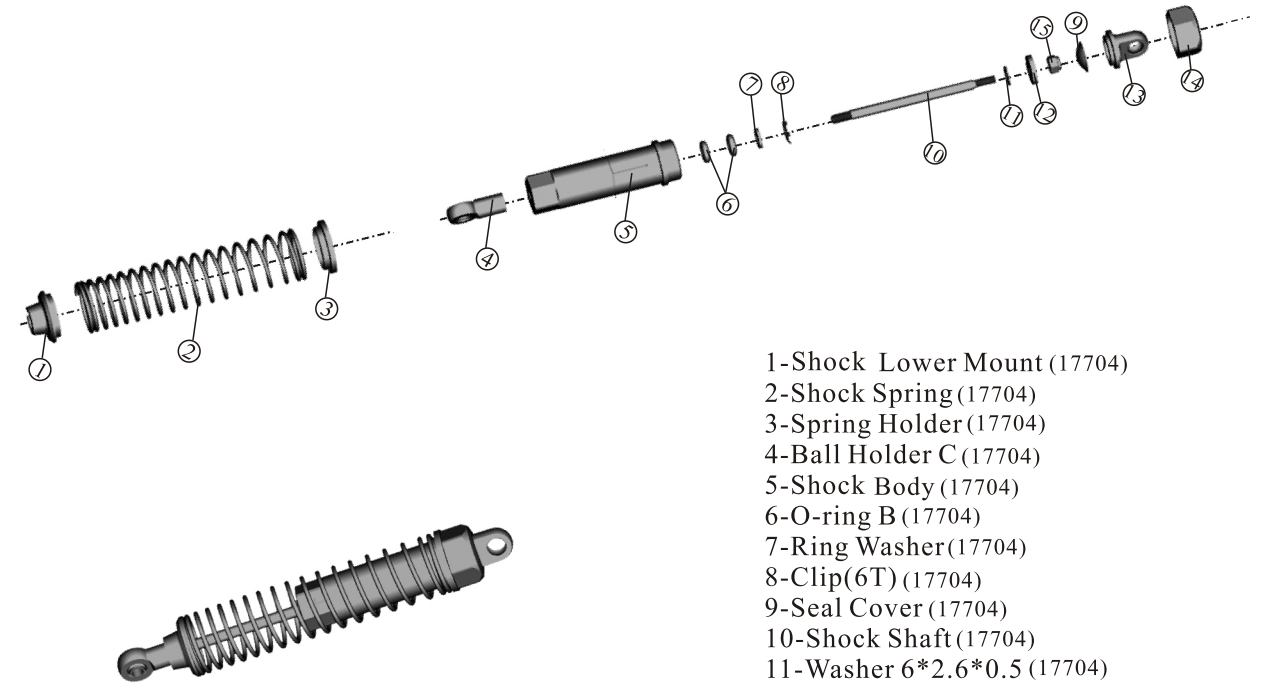

- 1-Shock Lower Mount (17704)
- 2-Shock Spring (17704)
- 3-Spring Holder (17704)
- 4-Ball Holder C (17704)
- 5-Shock Body (17704)
- 6-O-ring B (17704)
- 7-Ring Washer (17704)
- 8-Clip(6T) (17704)
- 9-Seal Cover (17704)
- 10-Shock Shaft (17704)
- 11-Washer 6\*2.6\*0.5 (17704)
- 12-Piston (17704)
- 13-Shock Top Holder (17704)
- 14-Shock Absorber Cap (17704)
- 15-Nylon Nut M2.5 (17704)



**1/10th Scale Monster Truck /Truggy  
/Off road ATV Steering /Servo Saver Assembly**

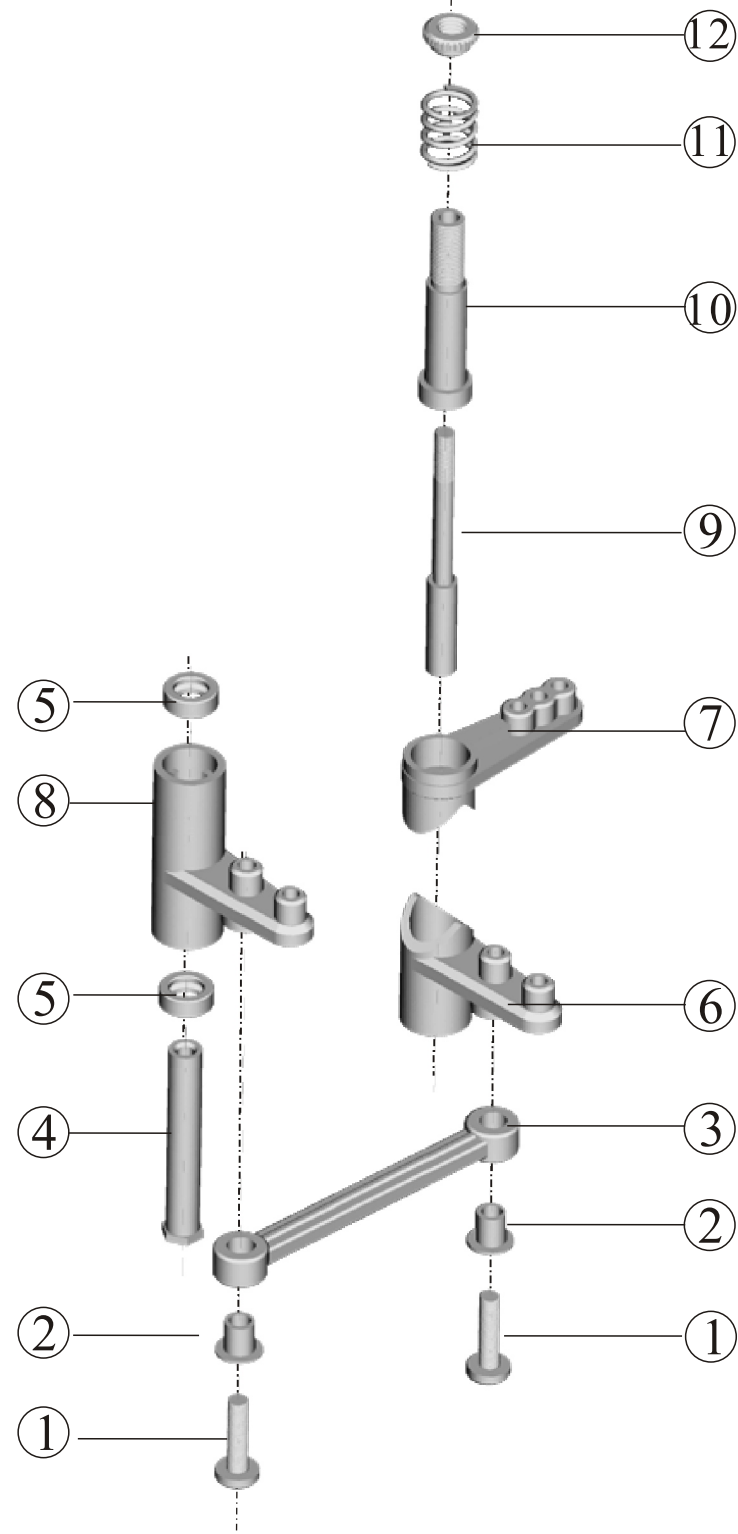

- 1-BT3\*14 BH Screw (02074)
- 2-Steering Bushing (02074)
- 3-Steering Shaft (02074)
- 4-Buffer Shaft Bushing A (02075)
- 5-Bearing  $\phi$  8\*5\*3 (02075)
- 6- Buffer Lower Mount (08425)
- 7-Buffer Upper Mount (08425)
- 8-Steering Arm (02075)
- 9-Buffer Shaft (08425)
- 10-Buffer Shaft Bushing B (08425)
- 11- Buffer Spring (08425)
- 12-Buffer Adjustable Ring (08425)

**Monster Truck/Truggy/Off road ATV**

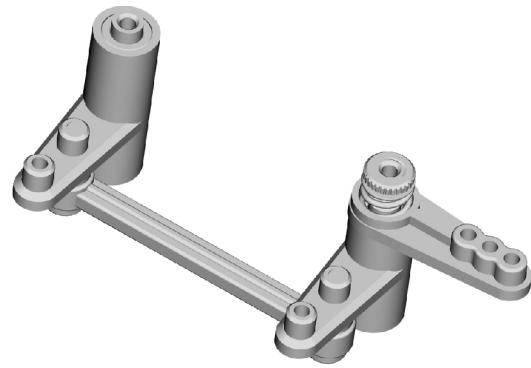

**1/10th Scale Monster Truck Diff. Box Assembly**

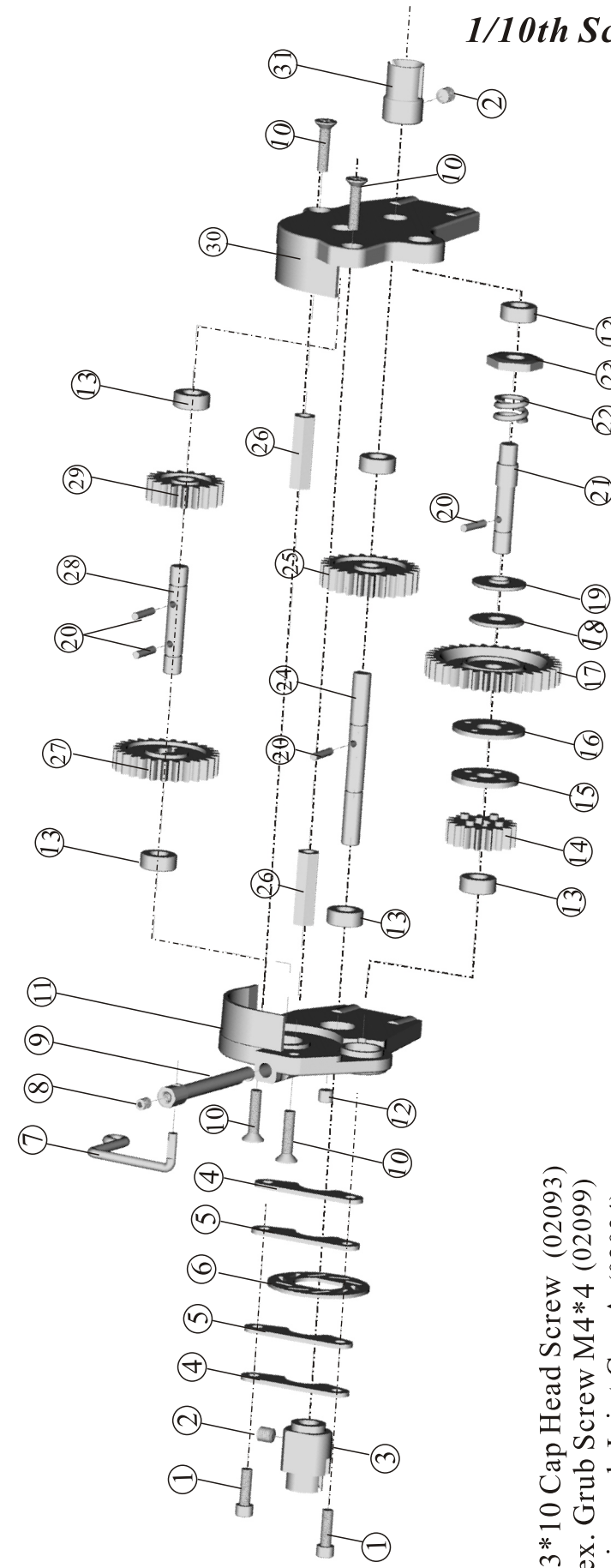

- 1-M3\*10 Cap Head Screw (02093)
- 2-Hex. Grub Screw M4\*4 (02099)
- 3-Universal Joint Cup A (02034)
- 4-Brake Disc (02044)
- 5-Friction Resistant Guard(02044)
- 6-Brake Pad (02044)
- 7-Brake Bar (08016)
- 8-Hex. Grub Screw M3\*4 (02098)
- 9-Brake Cam (08016)
- 10-ISO M3\*4 Screw (02092)
- 11- Centre Diff. Mount(Front) (08004)
- 12-Cam Assembly (08016)
- 13-Rolling Bearing 10\*5\*4 (02139)
- 14-Gear 2 (08033)
- 15-Overload Resistant Guard (08034)
- 16-Overload Resistant Guard (08034)
- 17-Gear 1 (08033)
- 18- Overload Resistant Guard (08034)
- 19- Overload Resistant Guard (08034)
- 20-Pin 2\*10 (08027)
- 21-First Step Axle (08018)
- 22-Overload Resistant Spring (08017)
- 23-Adjustable Nut (08017)
- 24-Third Step Axle(08026)
- 25-Gear 3 (08015)
- 26- Centre Diff. Holder (08025)
- 27-Gear 5 (08014)
- 28- Second Step Gear (08022)
- 29-Gear 4 (08014)
- 30-Centre Diff. Mount (rear) (08004)
- 31-Universal Joint Cup B(02016)

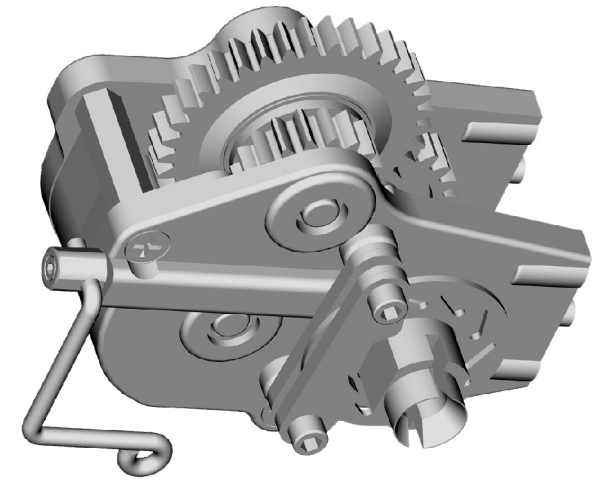

**Monster Truck**

**1/10th Scale Truggy/Off road ATV Diff. Assembly**

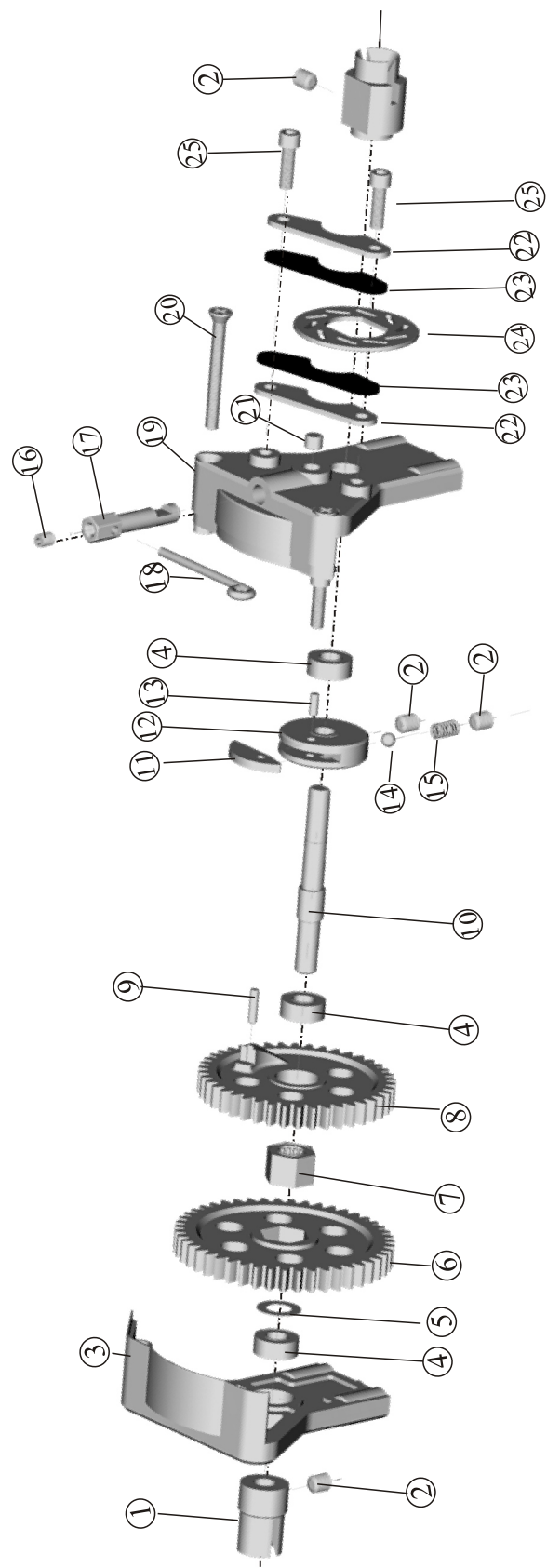

- 1-Universal Joint Cup B (02016)
- 2-Hex.Screw 4\*4 (02016)
- 3-Front Throttle Mount (02006)
- 4-Ball Bearing 10\*5\*4 (02139)
- 5-Washer (02194)
- 6-Throttle Big Gear (02040)
- 7-Hex.Bearing (02067)
- 8-Throttle Small Gear (02041)
- 9-Pin 2\*8 (02195)
- 10-2-Way Axle (02054)
- 11-Clutch Shoe (02045)
- 12-Clutch Shoe (02045)
- 13-Pin 2\*5 (02045)
- 14-Ball (02045)
- 15-2-Way Ring (02045)
- 16-Hex.Screw 3\*4 (02043)

- 17-Brake Cam (02043)
- 18-Brake Post (02043)
- 19-Throttle Rear Mount (02006)
- 20-TPE 3\*25 FH Screw (02090)
- 21-Cam Block (02043)
- 22-Brake Shoe (02044)
- 23-Lining(02044)
- 24-Brake Ring Shape Shoe (02044)
- 25-M3\*10 Cap Head Screw(02044)
- 26-Universal Joint Cup A (02034)

*Truggy/Off road ATV*

**1/10th Scale Monster Truck Gear Box Assembly**

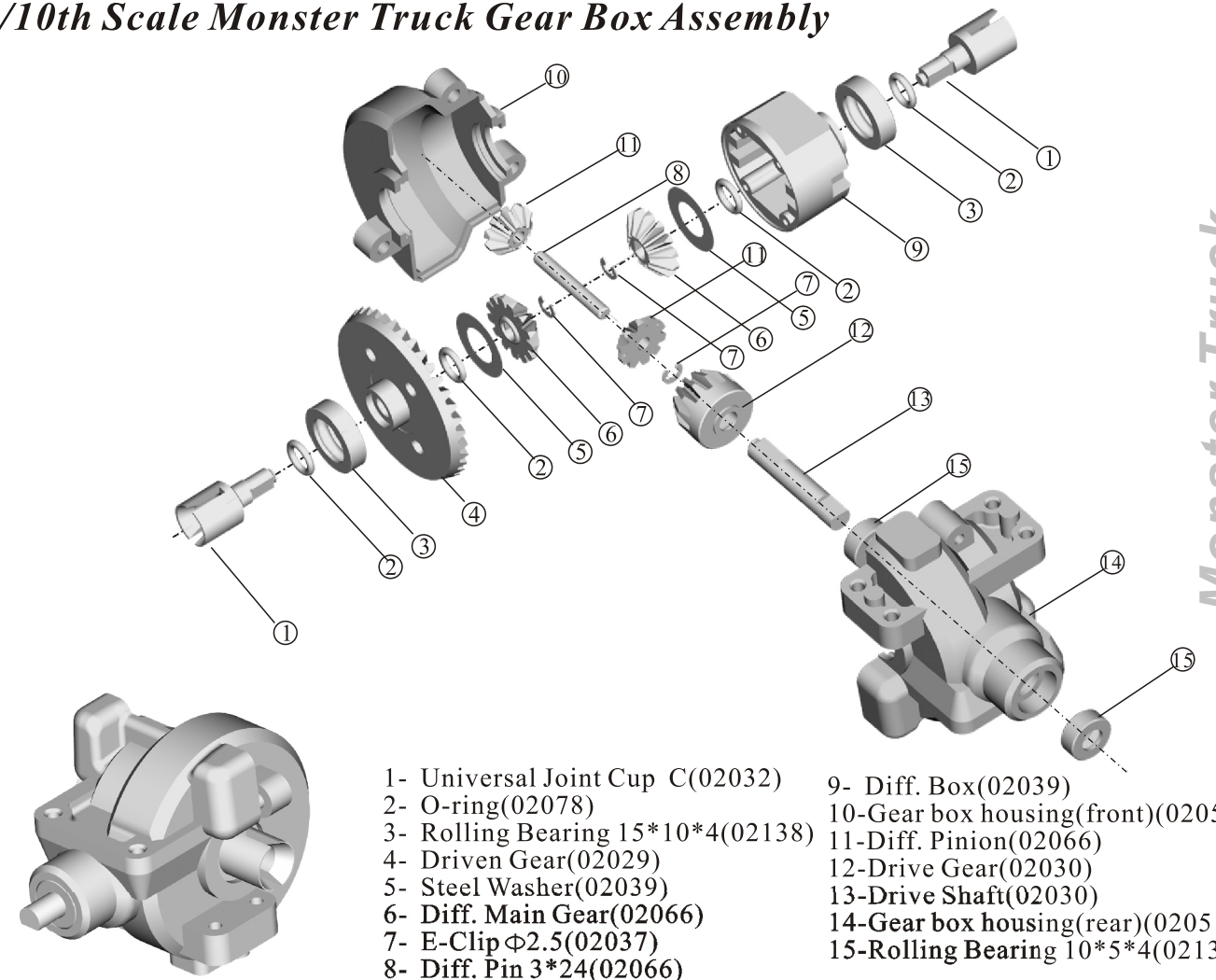

- 1- Universal Joint Cup C(02032)
- 2- O-ring(02078)
- 3- Rolling Bearing 15\*10\*4(02138)
- 4- Driven Gear(02029)
- 5- Steel Washer(02039)
- 6- Diff. Main Gear(02066)
- 7- E-Clip  $\Phi$ 2.5(02037)
- 8- Diff. Pin 3\*24(02066)
- 9- Diff. Box(02039)
- 10-Gear box housing(front)(02051)
- 11-Diff. Pinion(02066)
- 12-Drive Gear(02030)
- 13-Drive Shaft(02030)
- 14-Gear box housing(rear)(02051)
- 15-Rolling Bearing 10\*5\*4(02139)

*Monster Truck*

**1/10th Scale Monster Truck/Truggy/Off road ATV Exhaust Pipe**

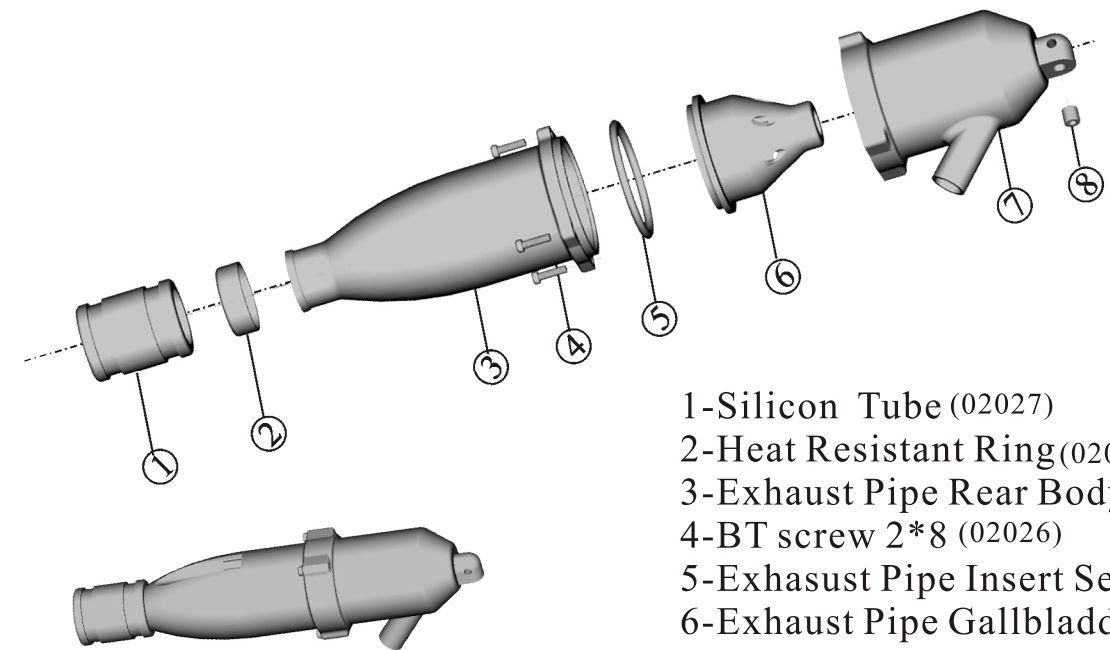

- 1-Silicon Tube (02027)
- 2-Heat Resistant Ring(02027)
- 3-Exhaust Pipe Rear Body (02026)
- 4-BT screw 2\*8 (02026)
- 5-Exhasust Pipe Insert Seal (02026)
- 6-Exhaust Pipe Gallbladder (02026)
- 7-Exhaust Pipe Front Body (02026)
- 8-M4\*4 Grub Screw(02026)

*Monster Truck/Truggy /Off road ATV*



**Front Gear Box Assembly(Truggy/Off road ATV)**

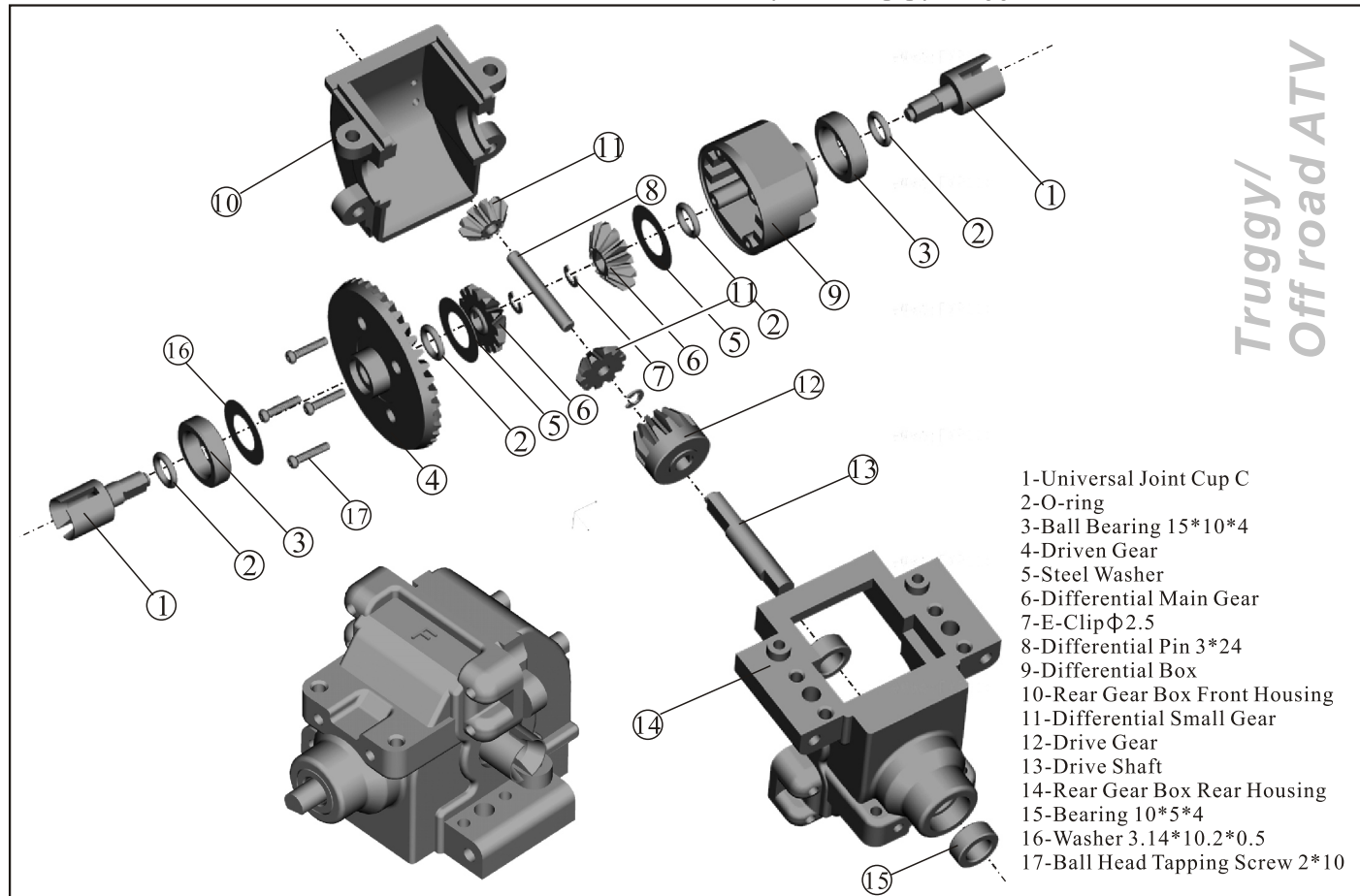

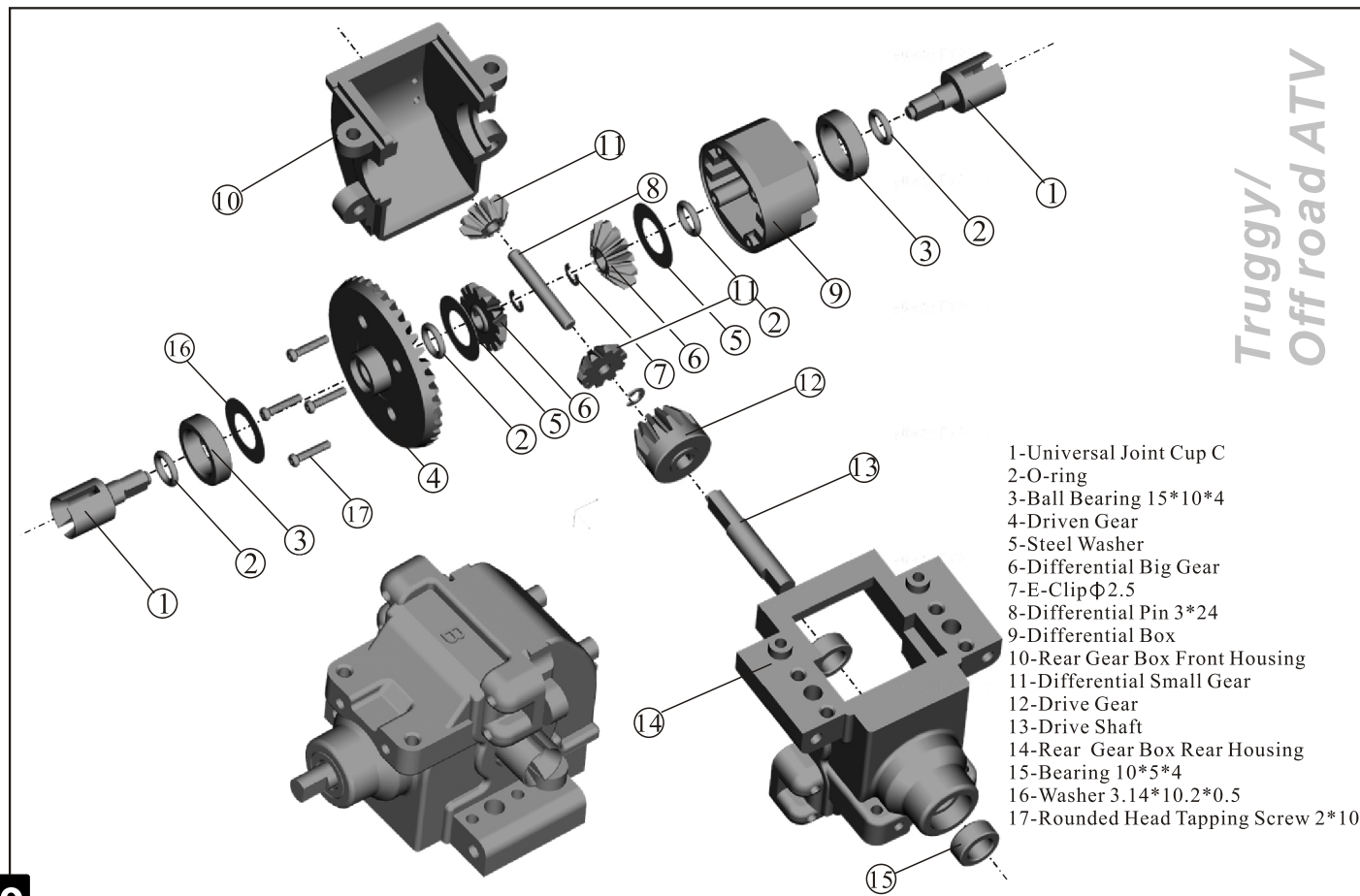

- 1-Universal Joint Cup C
- 2-O-ring
- 3-Ball Bearing 15\*10\*4
- 4-Driven Gear
- 5-Steel Washer
- 6-Differential Main Gear
- 7-E-Clip $\Phi$ 2.5
- 8-Differential Pin 3\*24
- 9-Differential Box
- 10-Rear Gear Box Front Housing
- 11-Differential Small Gear
- 12-Drive Gear
- 13-Drive Shaft
- 14-Rear Gear Box Rear Housing
- 15-Bearing 10\*5\*4
- 16-Washer 3.14\*10.2\*0.5
- 17-Ball Head Tapping Screw 2\*10

**Rear Gear Box Assembly(Truggy/Off road ATV)**



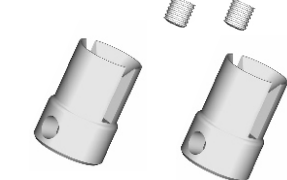
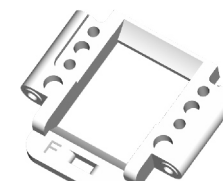

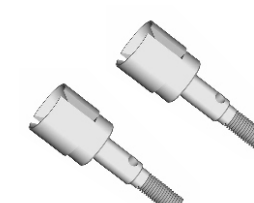

- 1-Universal Joint Cup C
- 2-O-ring
- 3-Ball Bearing 15\*10\*4
- 4-Driven Gear
- 5-Steel Washer
- 6-Differential Big Gear
- 7-E-Clip $\Phi$ 2.5
- 8-Differential Pin 3\*24
- 9-Differential Box
- 10-Rear Gear Box Front Housing
- 11-Differential Small Gear
- 12-Drive Gear
- 13-Drive Shaft
- 14-Rear Gear Box Rear Housing
- 15-Bearing 10\*5\*4
- 16-Washer 3.14\*10.2\*0.5
- 17-Rounded Head Tapping Screw 2\*10





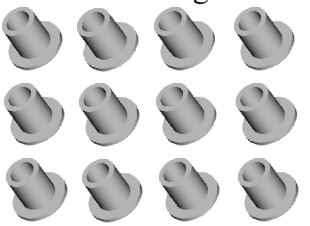
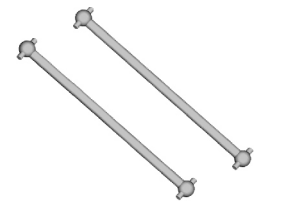
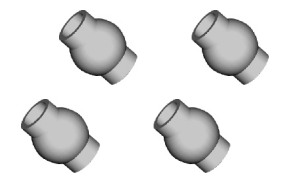

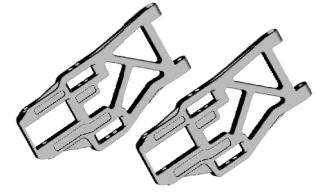

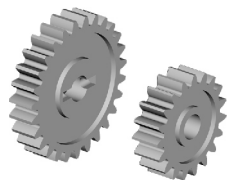
02003- Centre Rear Dog bone 2P Hole track:55mm Total length:61mm 	02004-Fuel Tank Complete 	02011-Handle 	02013-Rear Upright + grub screw 2P 
02014-Steering Hub 2P 	02015-Front Wheel Hub Carrier 2P 	02016-Universal Joint Cup B+grub screw 2P 	02017-Suspension Arm Pad 2P 
02021-Rear Suspension Arm Holder 	02022-Front Suspension Arm Holder 	02107-Clutch Bell (Single Gear) 	02024-Diff. Gear Complete 
08425-Steering Assembly A 	02026-Exhaust Pipe 	02027-Silicon Rubber Pipe 	02028-Air Filter w/Foam 
02029-Diff.Bevel Main Gear(steel) 	02030-Drive Gear 	02031-Exhaust Manifold 	02032-Universal Joint Cup C 
02033-Wheel Axle 2P 	02034-Universal Joint Cup A+screws 2P 	02036-Front Lower Suspension Arm Pin A 2P 	02037-E-Clip 12 pcs ( $\Phi$ 7, $\Phi$ 4, $\Phi$ 2.5, $\Phi$ 2.3) 

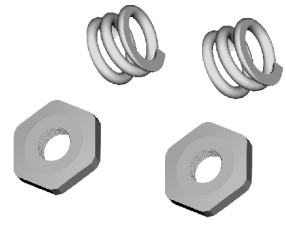
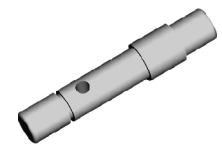
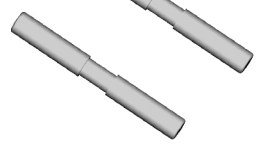
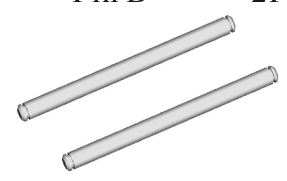
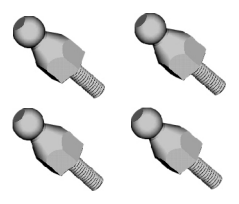

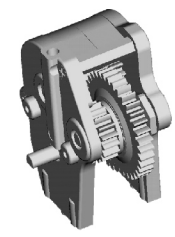

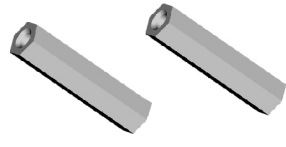

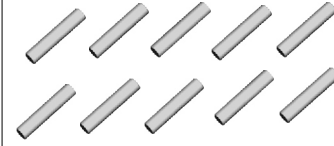
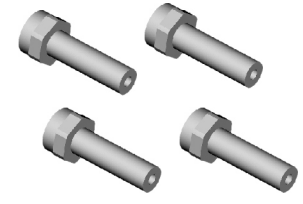
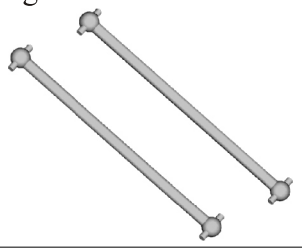
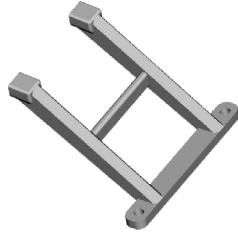
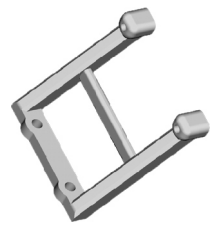
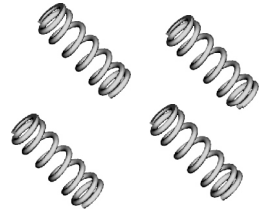
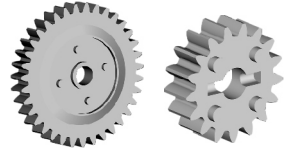

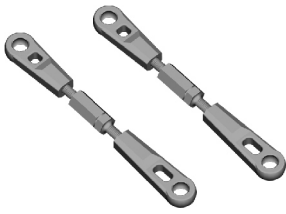
02038-Ball Head Screw 6P 	02039-Diff. Box (with 2 Rings & Steel washers) 	02044-Brake Disc 	02046-Radio Tray Post A 4P 
02047-Radio Tray Post B 4P 	02048-Clutch Shoe (w/Spring) 02048(M) 02048(F) 	02049-Engine Mount w/Cap Head Screw 	02050-Battery/ Receiver Box 
02051-Gear Box 	02053-Body Clip 8P 	02055-Nylon Nut M4 8P 	02056-Throttle Linkage Assembly 
02057-Antenna Pipe 4P 	02058-Fuel Tube 2P 	02059-Exhaust Pipe Holder w/Screw&Nut 	02063-Rear Lower Suspension Arm Pin A 2P 
02065-Engine Flywheel Post 2P 	02066-Diff. Pinions (Big& small) w/pin 	02068-Engine Flywheel 	02069-Radio Tray 
02070-Battery Compartment 	02071-Receiver 	02072-Servo Horn 	02073-Servo 

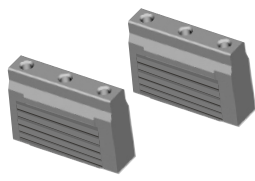
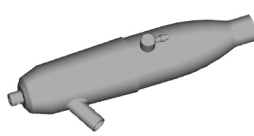
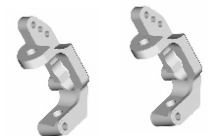
02074-Steering Ackerman Joint 	02075-Steering Assembly B 	02078- Seal Ring 12P 	02079-Oil bearing $\phi 15*\phi 10*4$ - 6pcs 
02080-Oil bearing $\phi 5*\phi 10*4$ - 8pcs 	02081-BT 3*8 BH Screw 6pcs 	02082-BT 3*10 BH Screw 10pcs 	02083-BT 3*12 BH Screw 6pcs 
02084-BT 3*18 BH Screw 4pcs 	02085- BT 2*8BH Screw 8pcs 	02086-BT 2*10 BH Screw 10pcs 	02087-TPF 3*10 FH Screw 15pcs 
02088-TPE 3*14 FH Screw 13pcs 	02089-TPE 3*15 FH Screw 9pcs 	02090-TPE 3*25 FH Screw 4pcs 	02092-ISO 3*10 Screw 8pcs 
02093-M 3*10 Cap Head Screw 10pcs 	02094-M 3*28 Cap Head Screw 4pcs 	02095-M 3*8 Cap Head Screw 4pcs 	02096- 3*10 Rounded Head Screw 6pcs 
02097-3*14 Rounded Head Screw 6pcs 	02098-M3*4 Grub Screw 8pcs 	02099-M 4*4 Grub Screw 10pcs 	02100- Wheel Hex. 8P 





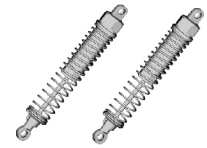
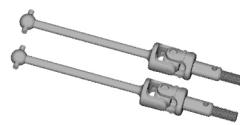

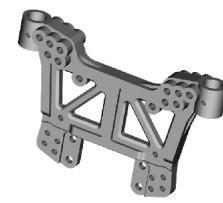
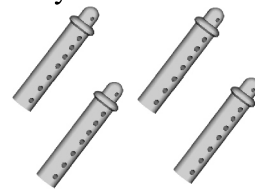
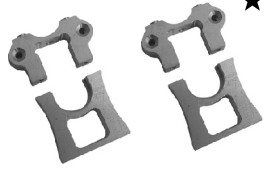
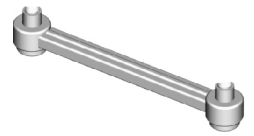
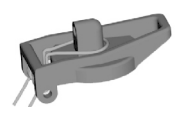

02101-Steering Plate Bushing 12P 	02102- Nylon Nut M3 6P 	02103- Zip Tie 6P 	02138- Ball Bearing $\phi 15 * \phi 10 * 4$ - 6pcs 
02139- Ball Bearing $\phi 10 * \phi 5 * 4$ - 8pcs 	06001-Chassis 	06006- Centre Front Dog bone 70mm 2P 	06007-Shock Ball 4P 
06015-Radio Tray Mount 	08001-Shock Absorber 2P 	08002-Front bumper 	08003-Rear bumper 
08004-Centre Diff. Mount 	08005-Front Lower Suspension Arm 2P 	08006-Rear Lower Suspension Arm 2P 	08007-Body Post 4P 
08008-Wheel Rim 2P 	08009-Tire 2P 	08010-Wheel Complete (08008+08009) 2P 	08012-Shock Tower 
08013-Main Gear Complete 	08014-Gear 4(19T) 3(27T) 	08015-Gear 5(25T) 	08016-Brake Cam+Bar +Screw 

08017-Adjustable Nut 	08018-First Step Axle 	08019-Rear Lower Suspension Arm Pin B 2P 	08020-Front Lower Suspension Arm Pin B 2P 
08021-Shock Ball Mount 4P 	08022-Second Step Axle 	08023-Main Gear Box 	08024-Discal screw M3*10*8 8P 
08025-Centre Diff. Post 2P 	08026-Third Step Axle 	08027-Pin 2*10 10P 	08028-Bumper Post 4P 
08029-Front/Rear Dogbone 89.5 mm 2P 	08030-Front Shock Tower Holder 	08031-Rear Shock Tower Holder 	08032-Bumper Spring 4P 
08033-Gear 1(35T) Gear 2 (17T) 	08034-Brake Pads 	08042-Front/Rear Link 2P 	03027-Charger/Battery Wire Connector 
06016-Servo Link 2P 			

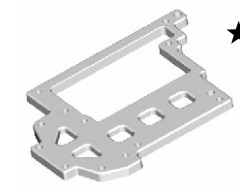
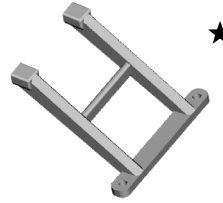
02115-Radio/Fuel Tank Tray  NEW NO.:102002	02128-Aluminum Engine Mount 2P  NEW NO.:102005	02124-Aluminum Exhaust Pipe  NEW NO.:102009	02132-Aluminum Front Hub Carrier (L/R)  NEW NO.:102010
02131-Aluminum Steering Hub(L/R)  NEW NO.:102011	02130-Aluminum Rear Hub Carrier (L/R)  NEW NO.:102012	02134-Aluminum Wheel Hex. Mount 4P  NEW NO.:102042	02191-Aluminum Nut M3 8P  NEW NO.:102048
02190-Aluminum Nut M4 4P  NEW NO.:102049	06048-Aluminum Front/rear & Servo Link 2P  NEW NO.:106017	08041-Aluminum Shock Absorber 2P  NEW NO.:108004	08046-Universal Drive Joint 2P  NEW NO.:108015
08055-Aluminum Front Lower Arm 2P  NEW NO.:108019	08056-Aluminum Rear Lower Arm 2P  NEW NO.:108021	08054-Aluminum Shock Tower  NEW NO.:108022	08047-Aluminum Body Post 4P  NEW NO.:108037
102025-Aluminum Centre Diff.Mount  ★	102040-Aluminum Ackerman Plate  ★	102057-Alum.Steering Servo Saver Complete  ★	102059-Aluminum Fuel Tank Cover  ★









The images with ★ are still undeveloped and will come in near future.

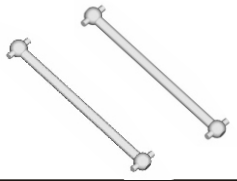
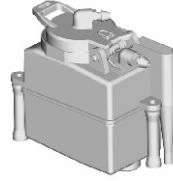



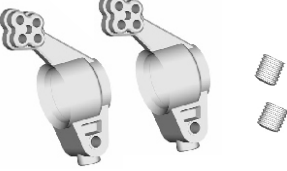
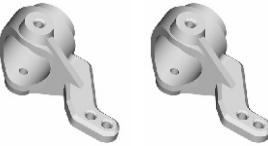
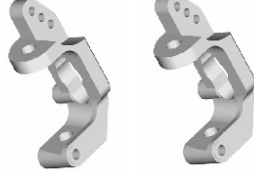
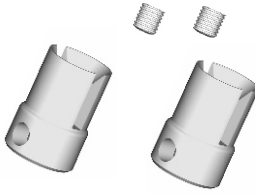
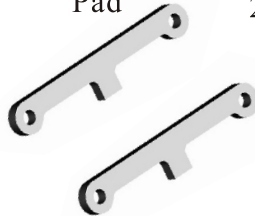
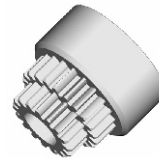
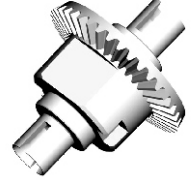
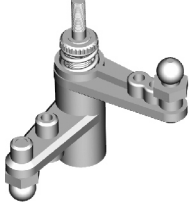
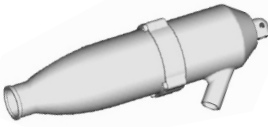

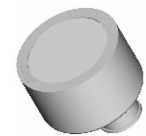

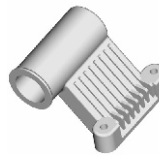
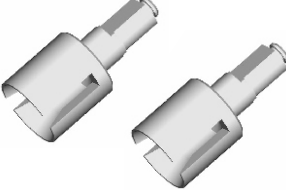
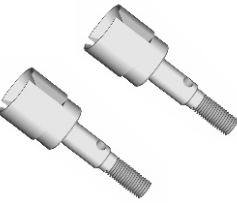
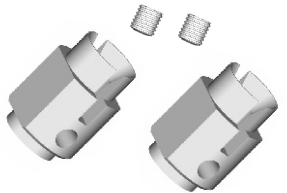
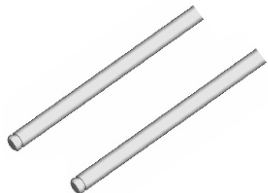
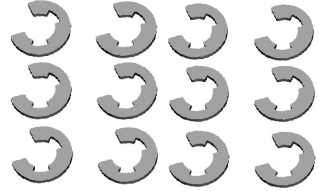

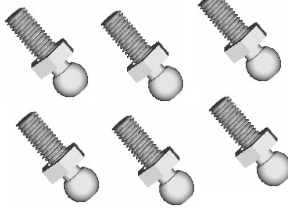
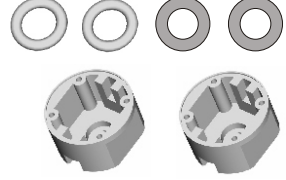
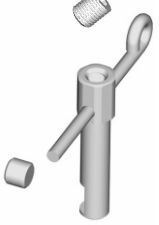
102006-Aluminum lightweight flywheel  ★	102063-Aluminum Combined Engine Mount/brace Complete  ★	102065-Compact Aluminum Radio Tray  ★	108035-Aluminum Front Brace  ★
108036-Aluminum Rear Brace  ★	102060-Aluminum Front Gear Box Mount  ★	102061-Aluminum Rear Gear Box Mount  ★	102064-Aluminum Battery case top cover  ★

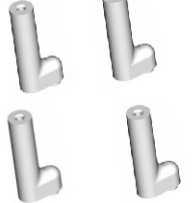

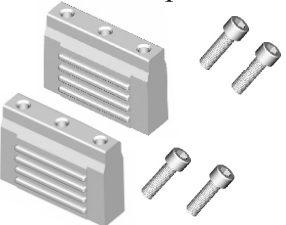
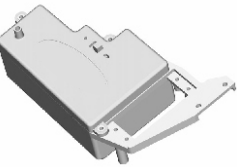
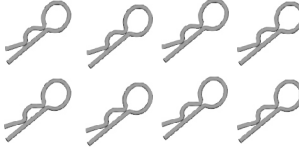

Notes:

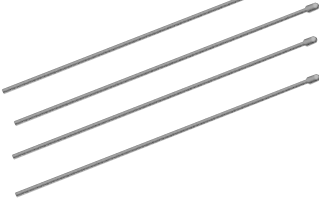
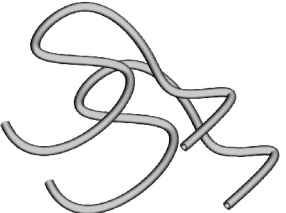
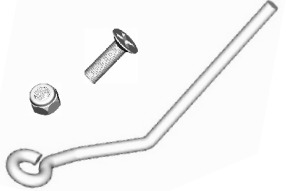
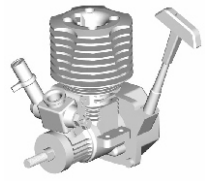
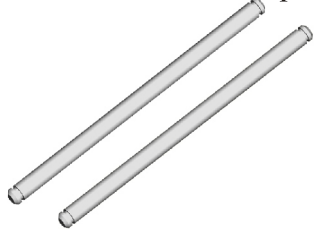
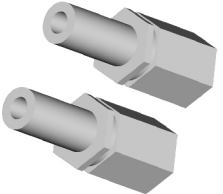
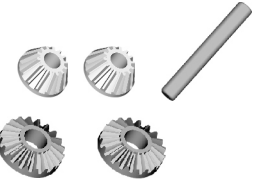
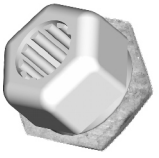

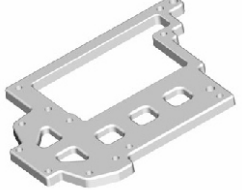
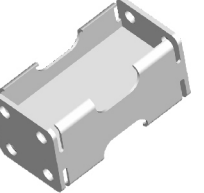

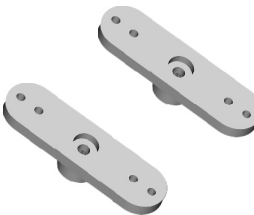
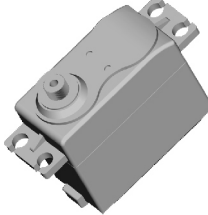
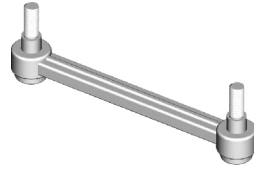
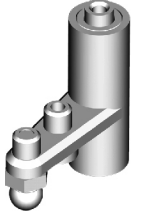
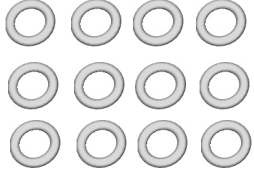
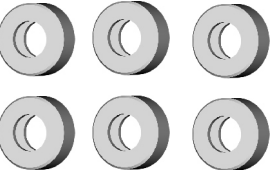
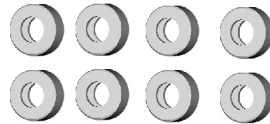
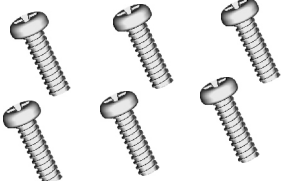
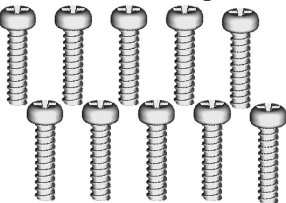
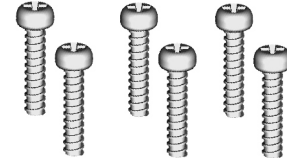
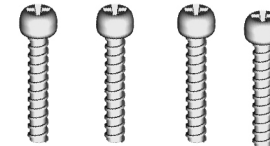
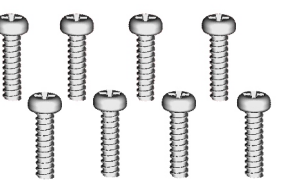
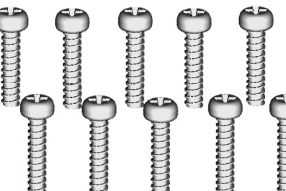

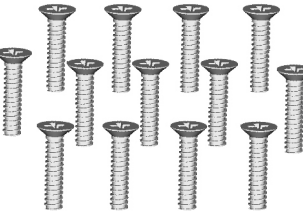
- 1.The actual received parts may vary from the images!
- 2.Optional parts are subject to change without prior notice.

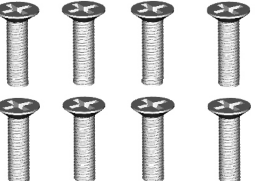
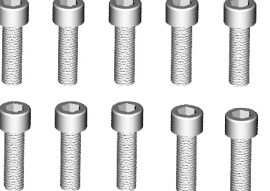
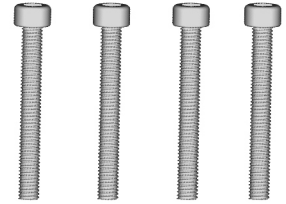
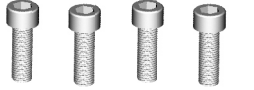
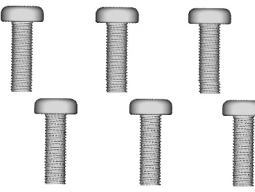
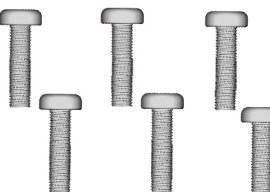

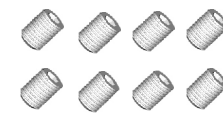
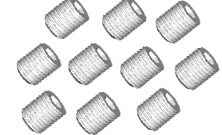
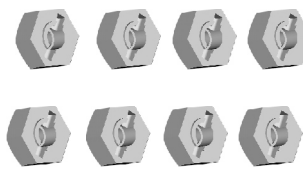
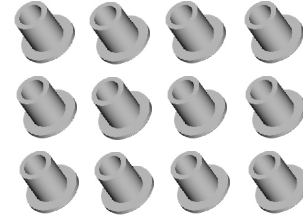

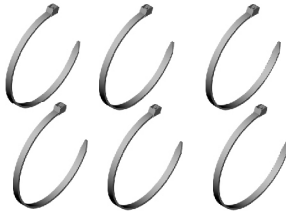
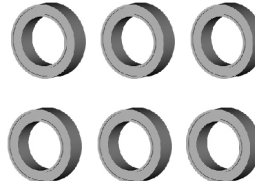
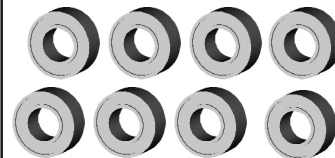
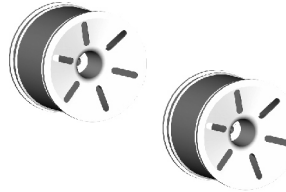

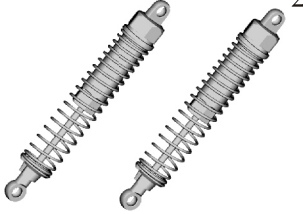
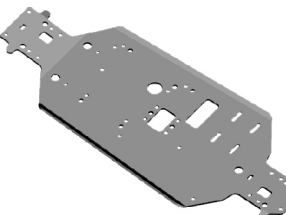
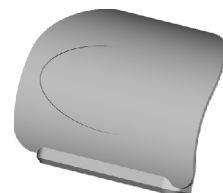
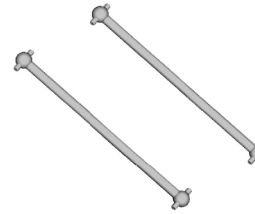
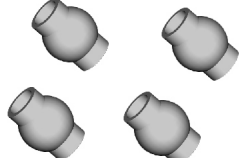
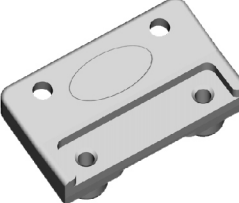

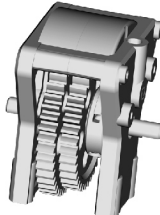
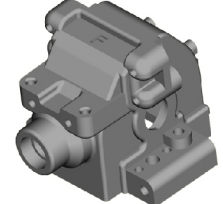
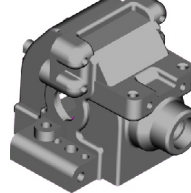
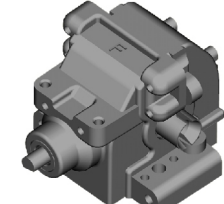
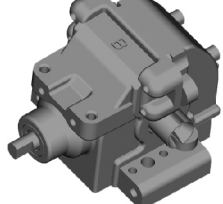
02003- Centre Rear Dog bone 2P Hole Track:55mm Total Length:61mm 	02004-Fuel Tank 	02005-Rear Bumper 	02006-Centre Diff. Mount 
02011-Handle 	02013-Rear Upright + grub screw 2P 	02014-Steering Hub 2P 	02015-Steering Arm Holder 2P 
02016-Universal Joint Cup B 2P 	02017-Suspension Arm Pad 2P 	02023- Clutch Bell (Double Gear) 	02024-Diff.Gear Complete 
08425-Steering Assembly A 	02026-Exhaust Pipe 	02027-Silicon Rubber Pipe 	02028-Air Filter w/ Foam 
02029-Diff.Main Gear (steel) 	02030-Drive Gear 	02031-Exhaust Manifold 	02032-Universal Joint Cup C 2P 
02033- Wheel Axle 2P 	02034-Universal Joint Cup A 2P 	02036-Front Lower Arm Pin A 2P 	02037-E-Clip (Φ7. Φ4.Φ2.5.Φ2.3) 12P 





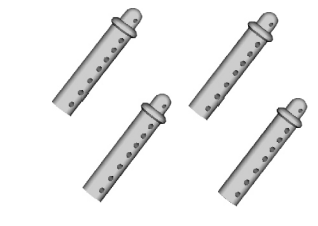

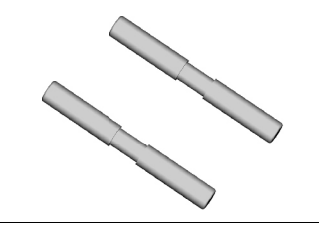
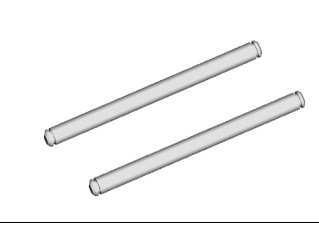
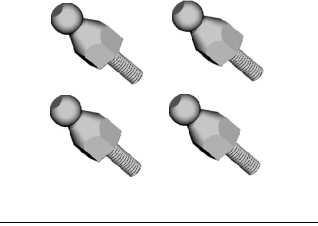
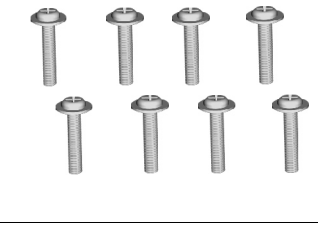
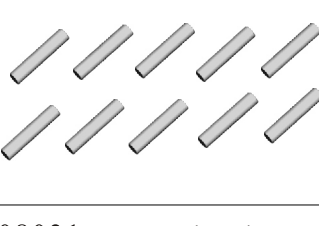
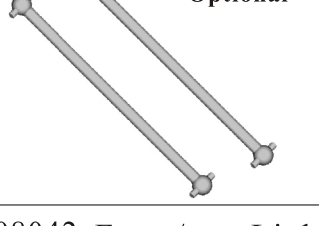
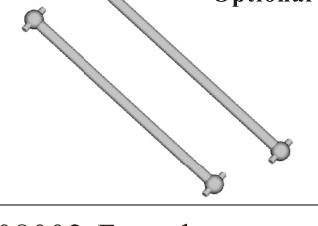
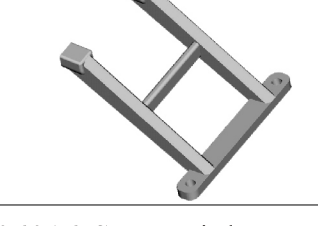
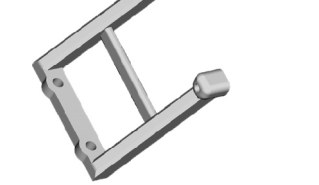

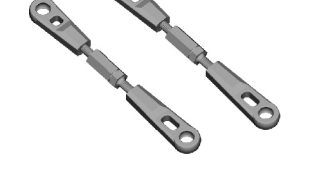

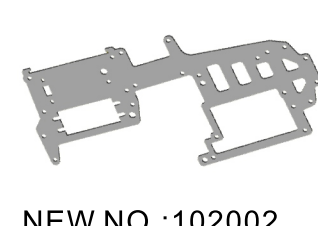

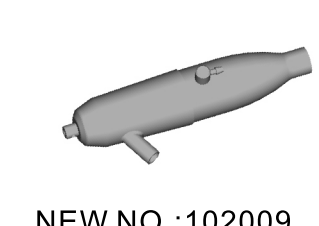

02038-Ball Head Screw 6P 	02039-Diff. Case (with 2 Rings & Steel washers) 	02043- Brake Cam 	02044-Disc Brake 
02046- Radio Tray Post A 4P 	02047- Radio Tray Post B 4P 	02048-Clutch Shoe 02048(M) 02048(F) 	02049-Engine Mount w/Cap Screw 
02050- Battery /Receiver Box 	02053-Body Clip 8P 	02054- Centre Gear Shaft 	02055-Nylon Nut M4 8P 
02056-Throttle Lever Assembly 	02057-Antenna Pipe 4P 	02058- Fuel Tube 2P 	02059-Engine Holder w/Screw & Nut 
02060-Engine 04-18CXP(Taiwan) 06-18CXP(Japan) 	02063-Rear Lower Arm Pin A 2pcs 	02065- Flywheel Pilot Post 2P 	02066-Diff. Pinions (big & small) w/pin 
06267-One-way Hex. Bearing w/Bearing Hex. Nut 	02068-Engine Flywheel 	02069-Radio Tray 	02070-Battery Compartment 

02071-Receiver 	02072-Servo Horn 	02073-Servo 	02074-Steering Joint 
02075-Steering Assembly B 	02078- Ring 12 pcs 	02079-Oil bearing $\phi 15*\phi 10*4$ - 6pcs 	02080-Oil bearing $\phi 5*\phi 10*4$ - 8pcs 
02081-BT 3*8 BH Screw 6pcs 	02082-BT 3*10 BH Screw 10pcs 	02083-BT 3*12 BH Screw 6pcs 	02084-BT 3*18 BH Screw 4pcs 
02085- BT 2*8BH Screw 8pcs 	02086-BT 2*10 BH Screw 10pcs 	02087-TPF 3*10 FH Screw 15pcs 	02088-TPE 3*14 FH Screw 13pc <sub>s</sub> 
02089-TPE 3*15 FH Screw 9pcs 	02090-TPE 3*25 FH Screw 4pcs 	02092-ISO 3*10 Screw 8pcs 	02093-M 3*10 Cap Head screw 10 pcs 
02094-M 3*28 Cap Head screw 4pcs 	02095-M 3*8 Cap Head screw 4pcs 	02096- 3*10 Cap Head screw 6pcs 	02097-3*14 Cap Head screw 6pcs 

02098-Grub Screw M3*4 8P 	02099-Grub Screw M4*4 10P 	02100-Wheel Hex. 8P 	02101-Steering Bushing 12P 
02102- Nylon Nut M3 6P 	02103- Zip Tie 6P 	02138- Ball Bearing $\phi 15*\phi 10*4$ - 6pcs 	02139- Ball Bearing $\phi 10*\phi 5*4$ - 8pcs 
17701-Wheel Rim 2P 	17702-Trye 2P 	17703-Wheel Complete 2P 	17704-Shock Absorber 2P 
06056-Chassis 	06003-Front Bumper  <i>For Truggy Only!</i>	06006- Centre Front Dog bone 70mm 2P 	06007-Shock Ball Stud 
06015-Radio Tray Mount 	06232-Spur Gear(47T) 	06033- Spur Gear(42T) 	06034-Centre Gear Complete 
06045-Front Gear Box Housing 	06046-Rear Gear Box Housing 	06063-Front Gear Box Complete 	06064-Rear Gear Box Complete 

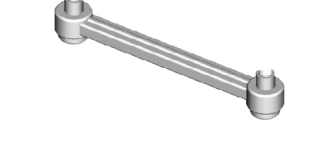
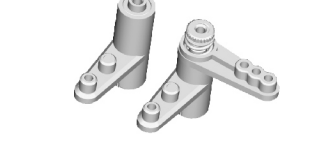
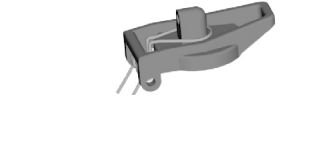

08005-Front Lower Suspension Arm 2P 	08006-Rear Lower Suspension Arm 2P 	08007-Body Post 4P 	08012-Shock Tower 
08019-Rear Lower Arm Pin B 2P 	08020-Front Lower Arm Pin B 2P 	08021-Shock Ball Head Holder 2P 	08024-Discal screw M3*10*8 8P 
08027-Pin 2*10 10P 	08029-Front/rear Dogbone 89.5mm 2P <i>Optional</i> 	08059-Front/rear Dogbone 88mm 2P <i>Optional</i> 	08030-Front Shock Tower Holder 
08031-Rear Shock Tower Holder 	08042-Front/rear Link 2P 	08002-Front bumper <i>For Monster ATV Only!</i> 	06016-Servo Link 2P 

02115-Radio/Fuel Tank Tray  NEW NO.:102002	02128-Aluminum Engine Mount 2P  NEW NO.:102005	02124-Aluminum Exhaust Pipe  NEW NO.:102009	02132-Aluminum Front Hub Carrier (L/R)  NEW NO.:102010
02131-Aluminum Steering Hub(L/R)  NEW NO.:102011	02130-Aluminum Rear Hub Carrier (L/R)  NEW NO.:102012	02134-Aluminum Wheel Hex. Mount 4P  NEW NO.:102042	02191-Aluminum Nut M3 8P  NEW NO.:102048
02190-Aluminum Nut M4 4P  NEW NO.:102049	06048-Aluminum Front/rear & Servo Link 2P  NEW NO.:106017	17705-Aluminum Shock Absorber 2P  NEW NO.:110004	08046-Universal Drive Joint 2P  NEW NO.:108015
08055-Aluminum Front Lower Arm 2P  NEW NO.:108019	08056-Aluminum Rear Lower Arm 2P  NEW NO.:108021	08054-Aluminum Shock Tower  NEW NO.:108022	08047-Aluminum Body Post 4P  NEW NO.:108037
102025-Aluminum Centre Diff.Mount ★ 	102040-Aluminum Ackerman Plate ★ 	102057-Alum.Steering Servo Saver Complete ★ 	102059-Aluminum Fuel Tank Cover ★ 

Following are the parts required for off road ATV only!

1/10th Scale Off road ATV Required Spare Parts :

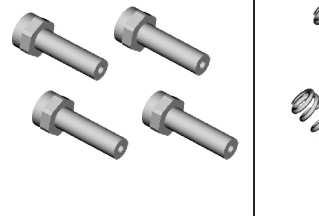
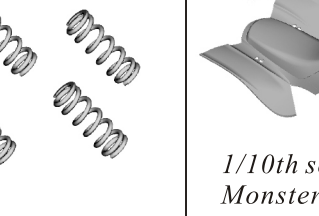
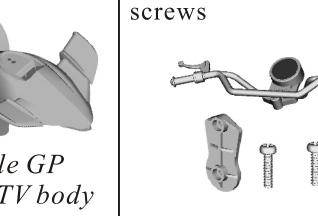
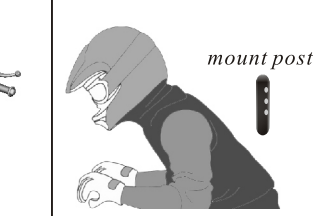
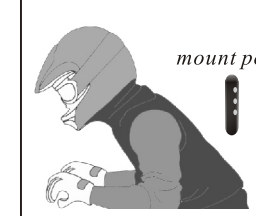
08028-Bumper Post 4P 	08032-Bumper Spring 4P 	ATV109-ATV body <i>1/10th scale GP Monster ATV body</i> 	ATV1002-ATV body handle with mount and screws 	ATV1003-ATV rider w/ the mount post <i>mount post</i> 
---	---	--	--	---

The images with ★ are still undeveloped and will come in near future.





1/10th Scale Truggy Full Assembly View

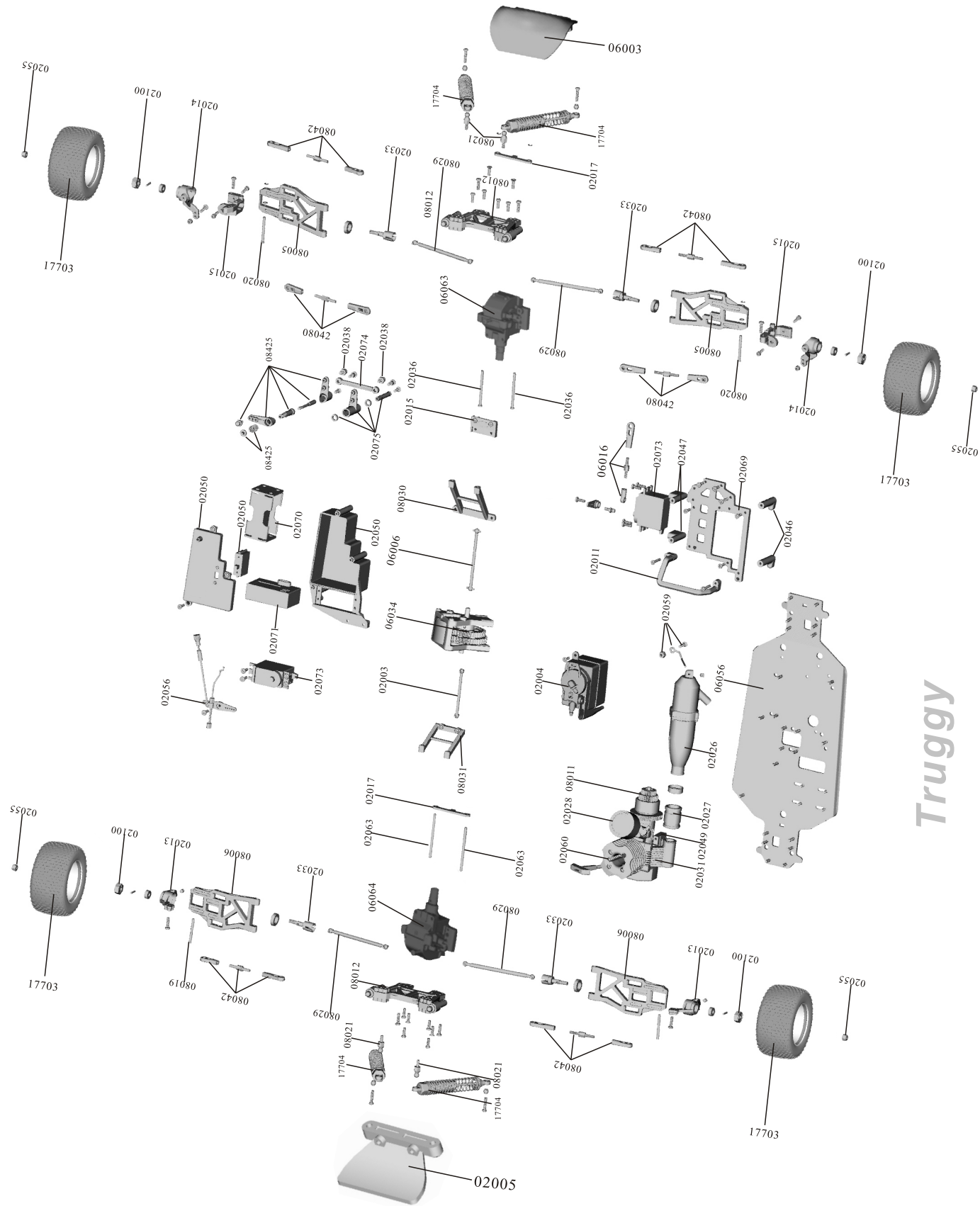

1/10th Scale Off road ATV Full Assembly View

